

DANIELI NANOMILL TECHNOLOGY: THE COMPETITIVE SOLUTION FOR LOCAL NEEDS IS THE ANSWER TO REGIONAL DEMANDS AND EXTRA LOW CAPEX INVESTMENTS¹

*Riccardo Pasinato²
Miguel Furlaneto³
Thomas Klein⁴*

Abstract

Since beginning of 2012 the newly founded Danieli Cento Met Swiss set-up is covering the field of very small steel plants fulfilling the investor targets of combining simple, reliable process equipment design with a consistent operational concept to produce commodity steel. Based on this vision the Danieli NanoMill concept for steel plants has been studied and developed. Danieli today is the only reliable plant supplier in position to offer the full panel of long product plants: i) the classical Danieli MiniMill configurations from 300.000 t/a to 1.500.000 t/a based on EAF melting; ii) the innovative MiDa - MicroMill Danieli concept with direct charging concept for plants in the range of 250.000 to 450.000 t/a based on EAF melting; iii) the reliable Danieli NanoMill concept based on either a newly developed NanoEAF or Induction Furnaces as melting units for a capacity range of typically 100.000 to 300.000 t/a. High flexibility of the complete NanoMill due to alternating operation of the primary melting units and the fully integrated downstream process lines. Looking particular into the needs of developing regions on the globe, it clearly turn out that we can find locations with a clear local need of long products, but with restriction in power quality and investment capability. Now there is an answer to such investment: the Danieli NanoMill. The Danieli NanoEAF with optimized size ranges called Nano² (5 t to 15 t tap weight) and Nano³ (15 t to 35 t tap weight) has been developed with a new optimized design concept for such tap sizes allowing optimized Capex costs without compromising the necessary technical performance. The NanoEAF idea has been the driving force also of the overall NanoMill concept to be fully flexible in adjustment to raw materials, utility conditions and power availability and quality. The paper will present very interesting ideas on overall layout, Capex and OPEX comparisons and will present the first orders under implementation for these kind of mills. The response from the market shows that these kind of mills have a potential future and need the a professional attention to ensure the product quality and process requirements. The paper will also present the influence of proper raw material preparation via recycling tools like e.g. shredder; to be in position to efficiently operate such small melting units.

Key words: NanoMill; NanoEAF; Steel Making; Induction furnace.

¹ *Technical contribution to the 44th Steelmaking Seminar, May, 26th-29th, 2013, Araxá, MG, Brazil.*

² *Process Engineer, Executive Manager Sales, Danieli Centro Met Swiss, Rheinfelden, Switzerland; r.pasinato@swiss.danieli.com.*

³ *Metallurgical Engineer, Sales, Danieli do Brasil S.A., Diadema, SP, Brasil; m.furlaneto@danieli.com.br.*

⁴ *Mechanical Engineer, Executive Manager Sales, Danieli Centro Met Swiss, Rheinfelden, Switzerland; t.klein@swiss.danieli.com.*

1 INTRODUCTION

Investments into a new Steel Making Plant are always driven by the same key factors e.g. available market for finished products, investment costs (CAPEX), operational costs (OPEX), availability of raw materials and electrical power, plant location, environmental issues, skilled man power etc.

Considering these key factors, the classical MiniMill Concepts were not matching the changing demands of the markets. Especially in the growing emerging markets, these concepts were simply oversized for the respective application.

Looking particular into the needs of developing regions on the globe, it clearly turns out that we can find locations with a clear local need of long products, but with restriction in power quality and investment capability.

Now there is an answer to such investment: the Danieli Nanomill.

The Danieli Nanoef, with optimized size ranges called NANO² (5t to 15t tap weight) and NANO³ (15t to 35t tap weight) has been developed with a new optimized design concept for such tap sizes allowing optimized CAPEX and OPEX without compromising the necessary technical performance. The NANOEF idea has been, beside the Induction Furnace technology as a primary melting unit, the driving force also for the overall NANOMILL concept to be fully flexible in respect to raw materials, utility conditions and power availability and quality.



Figure 1 . Danieli NanoMill.

A NanoMill is a regional-product focused mill. A mill that exploits availability of scrap from a particular area as well as the market for the finished product and converts scrap in the most efficient way to finished products with extreme short transport ways.

The NanoMill Concept is supporting the development of areas around the world where before no one had ever thought about building a steel making plant at all., a NanoMill becomes very feasible. As a consequence, the NanoMill is a magnet for other businesses and industries, which are to be established around the NanoMill for its operation.

Good Reasons for a NanoMill: - Scrap feed from local sources - design for local demand! - short and cheaper transports! - Scrap quality is getting worse! - Energy sources are limited and become more expensive! - Available landscape is restricted! - Environmental requirements are getting stricter every year! - Investment cost should

be as small as possible! - Operating cost should be as low as possible! - less equipment, smaller buildings at a lower price and faster to build and to startup.

2

3 DANIELI NANOMILL DESIGN CRITERIA

To serve the market in the best way Danieli has developed 5 ranges for the NanoMills: e.g. NANO¹⁰⁰ stands for a Melt Shop of a capacity of 100.000 t/a billets.

According to this nomenclature the following sizes are available:

- NANO¹⁰⁰ for 100.000 t/a
- NANO¹⁵⁰ for 150.000 t/a
- NANO²⁰⁰ for 200.000 t/a
- NANO²⁵⁰ for 250.000 t/a
- NANO³⁰⁰ for 300.000 t/a

Also the respective rolling mill configurations are following the same standardization philosophy.

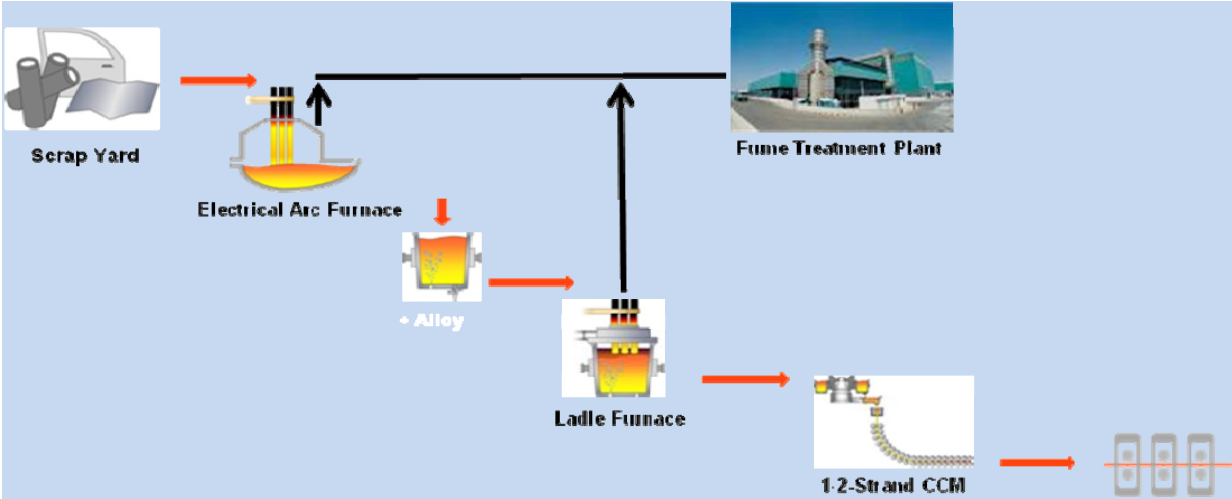

Figure 2. EAF based NanoMill – Process Route.

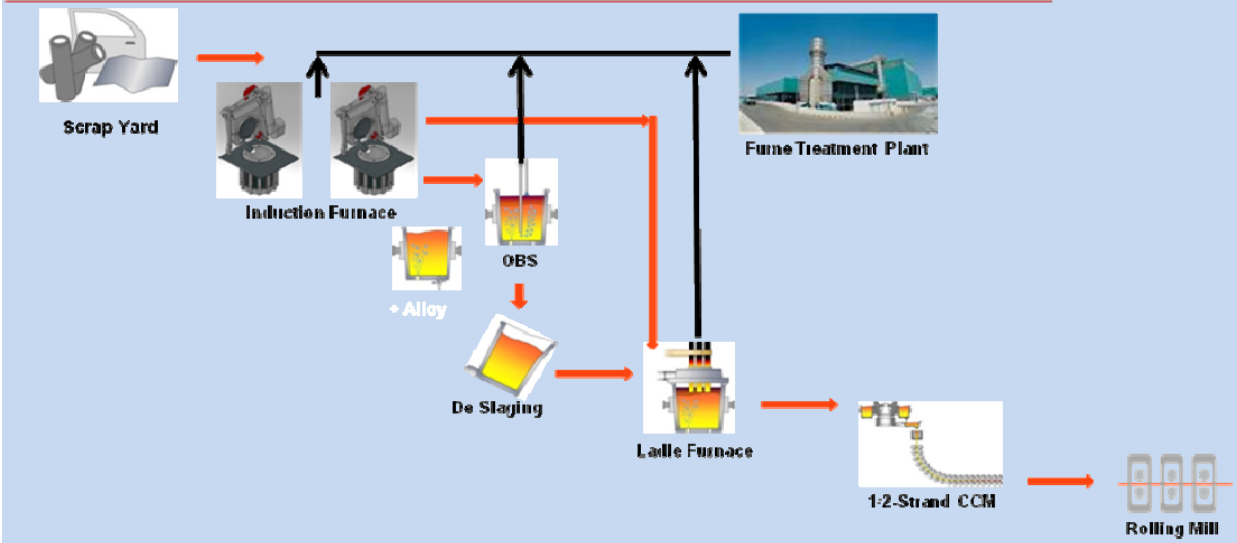

Figure 3. Induction Furnace based NanoMill – Process Route.

2.1 Main Process Units of the Nanomill

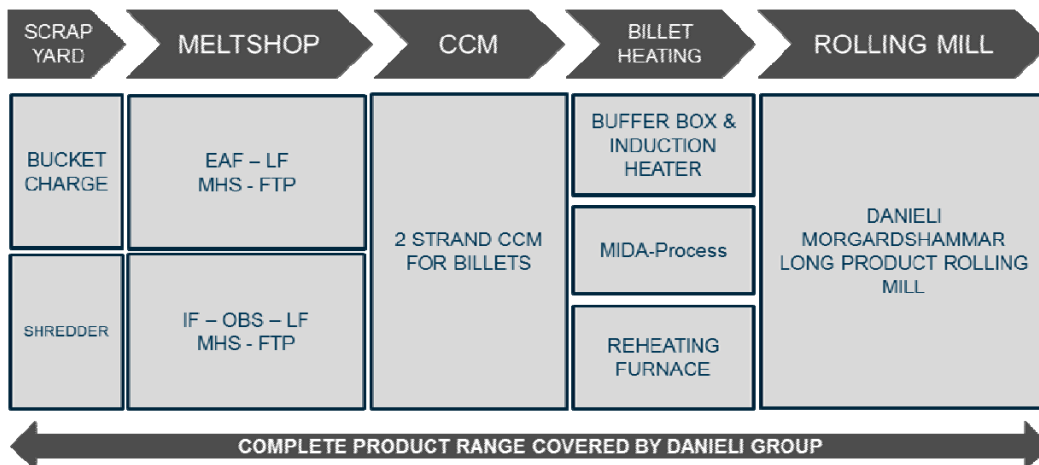

Figure 4. Danieli NanoMill – Main Process Units.

Main Technological Equipment and Developments at Danieli's NanoMill are:



Figure 5. Danieli NanoMill – Main Technological Equipment and Developments.

2.1.1 3Q Technology

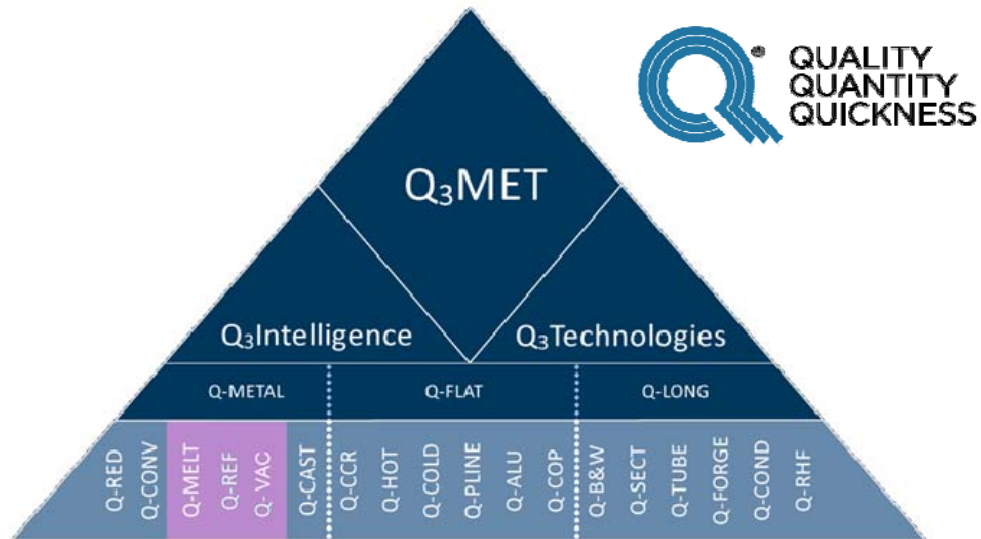

Figure 6. 3Q Technology

Advanced technology for Quality, Quantity and Quickness

- Quality Excellence in Quality and Product Quality certification
- Quantity High Productivity
- Quickness Fast Reaction to Situations

These are the tasks of our customers and the principles driving Danieli's solutions. This concept has led us to develop a new generation of full touch screen operator interface and pulpit design, to make operators work more efficiently and easily. The knowledge based approach consists of showing the operator only the useful information required for that precise process step.

The operators have the ability to work on different plane areas from one single pulpit, safely and quickly. They direct every machine as required by the process and with the control system driving them to the right action in the right time, whereas traditional plants depend mostly on the operators skill to choose the sequence and process steps.



Figure 7. Q3 Pulpit Concept, Operator Assistant and Performance Indicators

2.1.2 Main technological equipment of the NanoMill – Shredder plant

The usage of a Shredder as main scrap reparation system has been proven to be the most efficient method in order to guarantee a high quality and high yield raw material feed to the NanoMill. The outcome of the Shredder ensures operational and cost

effectivity, good yield of melting process, high productivity, proper control of metallurgical analysis.

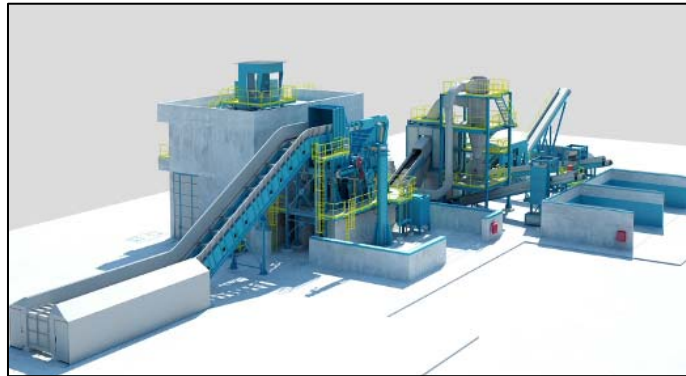

Figure 8. Danieli Lynxs Shredder.

DCR range - Production rates (Tonnes output per hour)

				Fe	Al	Coolant	Incinerator
DCR 1817							
180 x 170	600 kW	(800 HP)	100 kgs	12 ~ 20	10 ~ 35	Subject to density	Subject to feed
(72" x 70")	750 kW	(1000 HP)		16 ~ 24	15 ~ 45		
DCR 1822							
180 x 225	930 kW	(1250 HP)	100 kgs	30 ~ 40	15 ~ 65	Subject to density	Subject to feed
(72" x 90")	1030 kW	(1400 HP)		40 ~ 45	20 ~ 70		
DCR 1827							
180 x 270	930 kW	(1250 HP)	100 kgs	35 ~ 40	15 ~ 65	Subject to density	Subject to feed
(72" x 106")	1030 kW	(1400 HP)		40 ~ 45	20 ~ 70		
	1500 kW	(2000 HP)		50 ~ 75	20 ~ 100		
DCR 2227							
225 x 270	1500 kW	(2000 HP)	170 kgs	50 ~ 75	20 ~ 100	Subject to density	Subject to feed
(88" x 106")	1875 kW	(2500 HP)		60 ~ 80	-		
	2250 kW	(3000 HP)		70 ~ 90	-		
	2625 kW	(3500 HP)		80 ~ 100	-		
	3000 kW	(4000 HP)		90 ~ 120	-		
DCR 2727							
270 x 270	3000 kW	(4000 HP)	280 kgs	100 ~ 130	-	-	-
(106" x 106")	4420 kW	(6000 HP)		120 ~ 180	-	-	-
	5220 kW	(7000 HP)		140 ~ 210	-	-	-
DCR 3230							
325 x 300	4420 kW	(6000 HP)	395 kgs	150 ~ 200	-	-	-
(128" x 118")	5220 kW	(7000 HP)		180 ~ 240	-	-	-
	6000 kW	(8000 HP)		210 ~ 280	-	-	-
	7500 kW	(10000 HP)		240 ~ 300	-	-	-

Figure 9. Comparison of available Danieli Lynxs Shredders and their characteristics.

Beside the shredder machines, other scrap preparation systems e.g. scrap shears and pre-shredders are used to fully cover all scrap preparation activities and logistics.

2.1.3 Main technological equipment of the NanoMill – primary melting facilities

- **NanoEAF**

The NanoMill has two different process concepts for the primary melting aggregates. The melting can be done in the Danieli NanoEAF, which has been especially developed for the usage in the NanoMills and mainly consists of two sizes which covers the tapping range of 5t to 15t. NANO² and NANO³ for 15t to 35t. They are available as full or half platform design and with EBT or Spout tapping.

The electrical Design of the NanoEAF can be AC or DC depending on the individual requirements.

A special NanoRobox door lance for carbon and oxygen injection via the slag door has been developed in order to complete the system.

Alternatively, a complete Injection System can be installed including Burners, Supersonic Oxygen Lances, Carbon and Lime Injectors, according to special requirements.

The technical development was driven by the market needs in having an NanoEAF which fulfills the following criteria:

reliable design, friendly & simple maintenance, proven technology, no restriction in raw material charge, small tap weight, low investment cost, consideration of limited electrical power availability, short power off times, flexible tapping concepts, possibility of oxygen injection, no limitation on steel grade qualities.

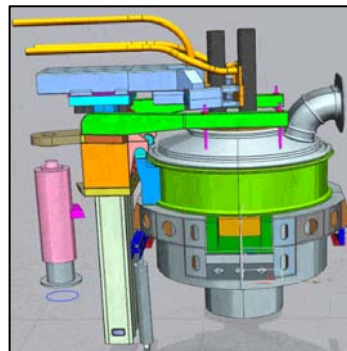

Figure 10. Danieli NanoEAF - Slag side view.

	NANO ²			NANO ³				
Heat size (t)	5	10	15	15	20	25	30	35
Diameter (m)	2.8	3.2	3.5	3.5	3.5	4.3	4.3	4.3
Power (MW)	6.1	9.1	11.4	13.0	15.2	19.0	22.8	26.6
Productivity (tph)	3.7	10.9	16.4	18.0	23.1	30	37.5	43.8
Tap-to-tap time (min)	82	55	55	50	52	50	48	48
Tapping system	Spout			Spout and EBT				
Chemical packages	Door Lance			Door Lance or Modules				
Design	AC and DC			AC and DC				
Charge Buckets	2			2				
Hot Heel	max. 15% tap weight			max. 15% tap weight				

Figure 11. NanoEAF sizes and characteristics.

- **Induction Furnace**

As an alternative primary melting system, the Induction Furnace (IF) technology has been applied for NanoMills, where only a limited electrical power is available and the production is limited to commodity steel like rebars. Medium-frequency coreless Induction Furnace for a tap weight of 5-35t with a converter power of 3-18 MW are mainly used. The scrap charge is done by semiautomatic scrap charging cars which are fed by the Meltshop cranes (Fig. 14).

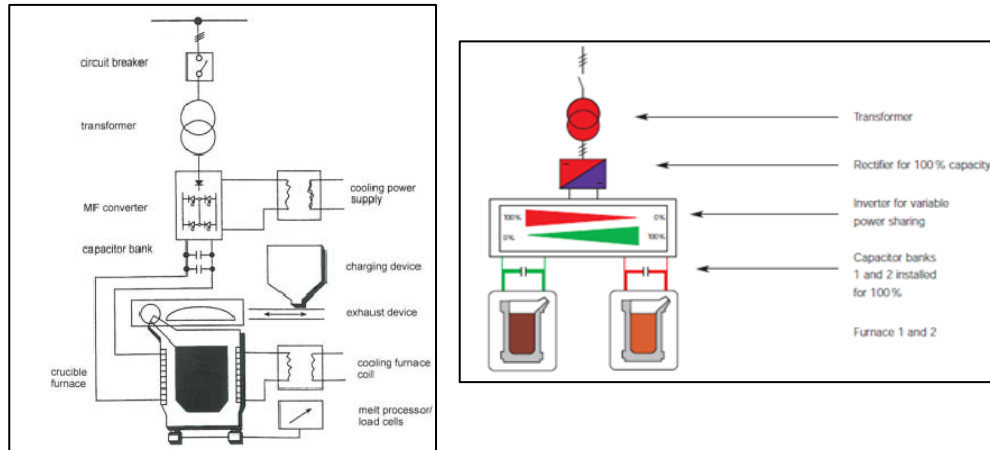

Figures 12. The main components of a High Performance Induction Furnace (HP - IF) and typical Tandem configuration

Depending on the aimed production, IF's are either arranged as one IF with 2 crucibles where one crucible is in melting operation and the second crucible in relining / sintering mode, or the arrangement of the IF is extended to a two IF with 4 crucibles (2 in operation + 2 in relining / sintering mode). The arrangement of the IF's within the plant is very important for the overall plant logistic and plays an important role in the development of the NanoMill overall layout. Fume exhaust during charging and tapping is done via a special suction hood (Fig. 14) which limits the overall offgas treatment volumes to a minimum.

Even if no electrical power is available from the public network, the power for the IF can be produced by compact Diesel generators which are grouped to small units to cover the dirty bus bar (IF, LF), clean bus bar (Auxiliaries + Rolling Mill) and Shredder plant.

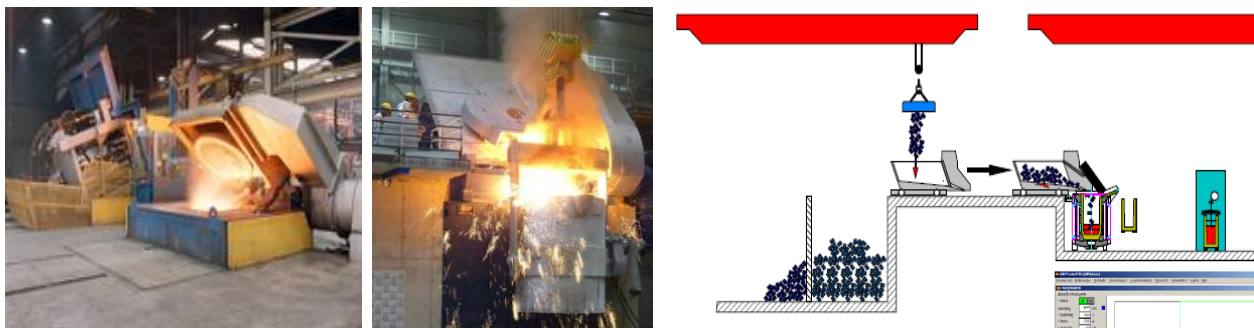

Figures 13. Induction Furnace Offgas System and Charging System

2.1.4 Main technological equipment of the NanoMill – secondary metallurgy

The need of a secondary metallurgical treatment facility is a must in a modern NanoMill and is covered by a small sized ladle furnace which guarantees the

chemical composition of the melt and operates as a production buffer between primary melting systems and the downstream production facilities.

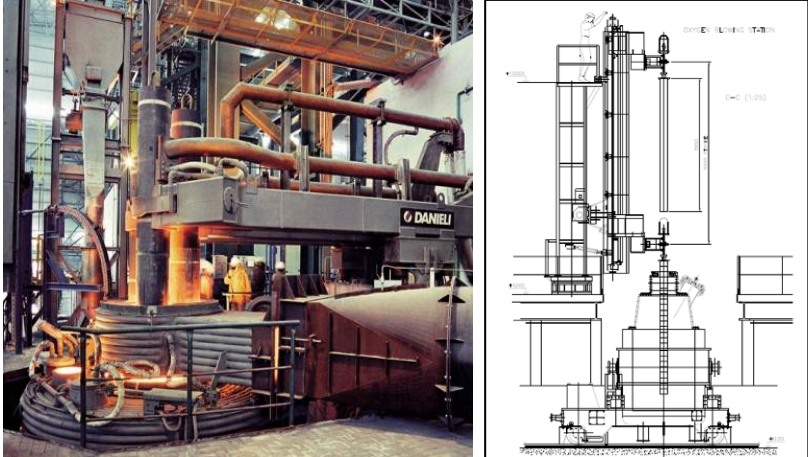

Figure 14. Danieli Ladle Furnace and Oxygen Blowing Station.

In case of having an induction furnace as a primary melting unit, the implementation of an additional Oxygen Blowing Stand (O.B.S) in front of the LF is foreseen for decarburization and de-phosphorization purposes.

A consumable oxygen lance is vertically lowered into the steel bath and oxygen, with a flow rate between 500 – 1000 Nm³/h, is injected into the steel bath. After the de-phosphorization process, the oxidized slag is removed by deslagging, which is performed by tilting the ladle 10-20° on the tiltable ladle car with intensive stirring and if necessary the ladle slag is raked off for clear metal transfer to the Ladle Furnace station.

2.1.5 Main technological equipment of the NanoMill – Casting

After the secondary treatment of the steel, the ladle is transferred to a conventional 1-2 strand Continuous Casting Machine CCM with 7m radius. The billet sizes produced here are in the range of 100x100mm to 160x160mm square and lengths between 4-12m => full flexibility to fulfill market requirements.

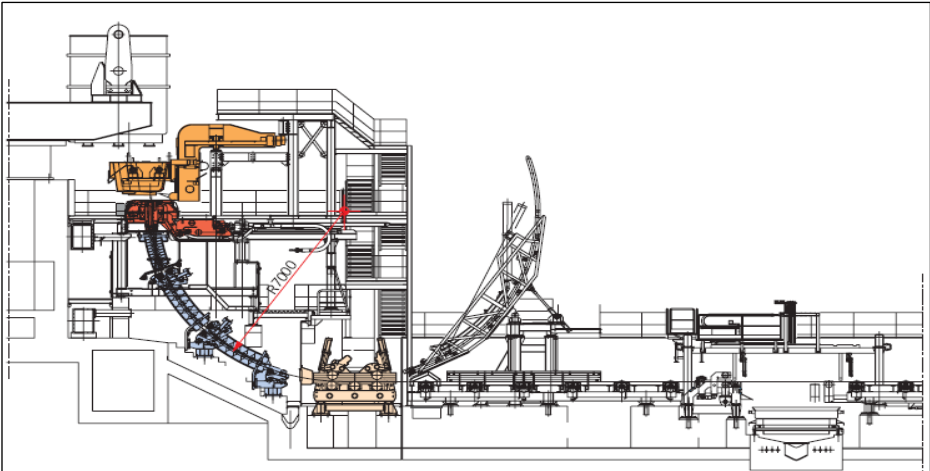

Figure 15. Danieli Continuous Casting Machine.

Proven technology is implemented, as e.g.

- ladle turret for high operational safety;
- Maximum refractory life and low and reliable temperature drop during casting due to delta-shape tundish design;
- Reduction in operation costs as a result of Steel flow regulation through Flying Nozzle Change system (FNC);
- unlimited sequence length due to flying tundish technology;
- improving metallurgical quality and achieving more flexibility in operating conditions thanks to the installation of Mould Electro Magnetic Stirrers (M-EMS).

2.1.6 Main technological equipment of the NanoMill – rolling mill

The Rolling Mill (RM) follows the concept of the NanoMill:



Figure 16. Danieli NanoMill concepts.

The RM ensures a full flexibility in its technical configuration to fulfill also requirements for the production of wire rod or light sections.

Main rebar dimensions are depending on the local requirements and cover the full finished product range between 8- 40mm.

Danieli is in the position to provide beside the classical type of Reheating Furnace (gas / oil fired pusher or walking beam type) also the possibility of an induction heater.

- Applicable in case no gas/fuel available
- Requires fully synchronized Casting & Rolling process (Billets re-heating from ambient to rolling temperature only as an emergency operating condition)
- Also with induction heater a constant and correct temperature along the billet required for rolling operation can be achieved.
-



Figure 17. Danieli rolling mill and induction heater.

2.1.7. Main technological equipment of the NanoMill – auxiliary integration plants

All auxiliary integration facilities needed for the continuous operation of the plant are considered in the NanoMill concept and are designed according to the specific country requirements.



Figure 18. Danieli Cranes, FTP and WTP.

All cranes supplied from scrap yard to billet handling are modern reliable cranes in heavy duty design with all applicable features for the operation in a steel plant environment.

Fume treatment plant to ensure the environmental compliance with the usual European and international standards. The NanoMill is the most environmental friendly steel making process unit. All emitted waste gases are collected and treated by a Fume Treatment Plant.

Low CO₂ emissions due to the charging of clean scrap processed by the shredder plant and/ or usage of the IF Technology.

Water treatment plant to secure the correct re-cooling of the process water used in the different process steps.

Other auxiliaries are defined according to the process needs.

Overall layout configuration from a „single source“ principle – ensuring the avoidance of logistical problems.

2.2 NanoMill Regional Markets



Figure 19. Typical land areas covered by a NanoMill.

NanoMills are economically-sized to cover regional market demand in a circumference of approx. 300km, where scrap is collected, transported over a short distance to the NanoMill and following processed and converted into finished products for the construction industries.

2.3 NanoMill Space Requirements

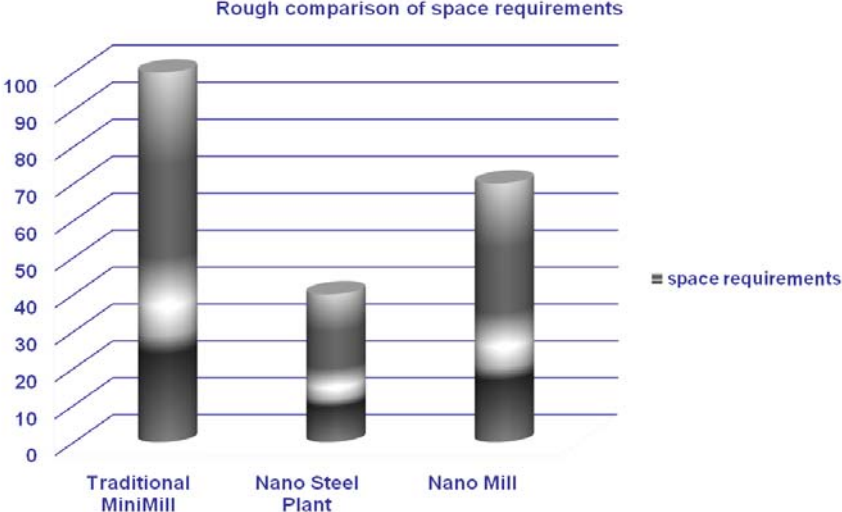

Figure 20. Comparison space requirements for different plant.

2.4 NanoMill Reference Layouts

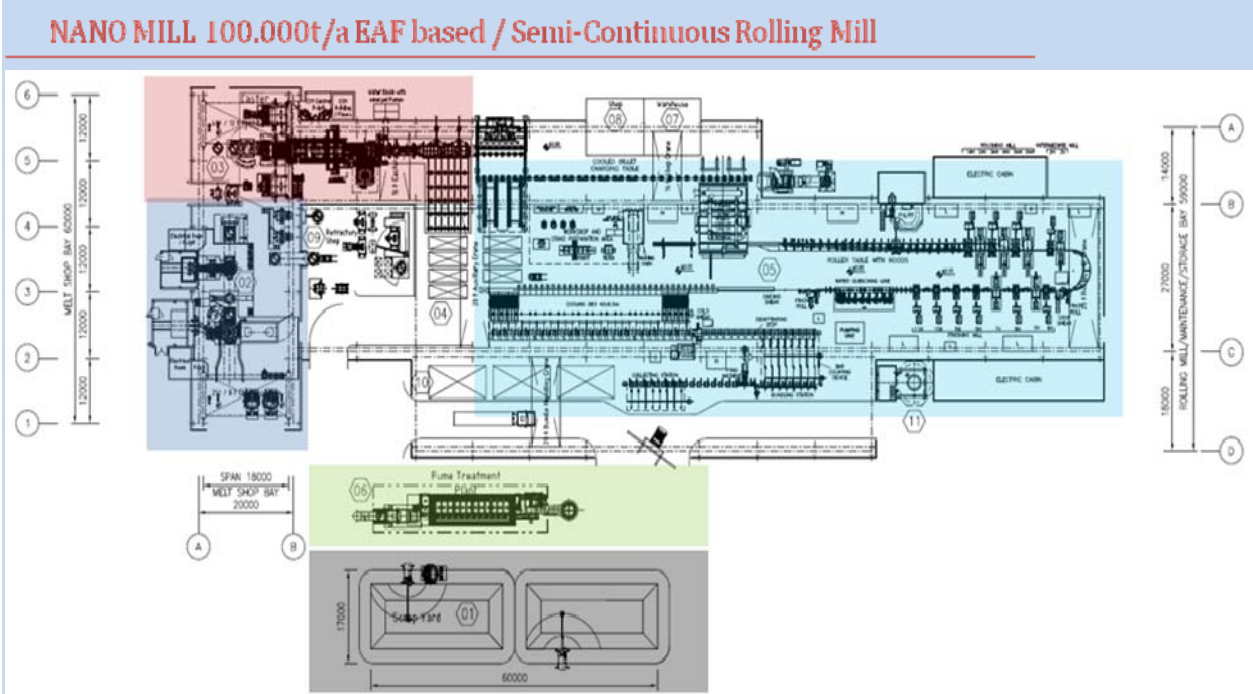

Figure 21. NanoMill 100,000 t/y EAF based / Semi-Continuous Rolling Mill.

NANO MILL 200.000t/a EAF based / Continuous Rolling Mill

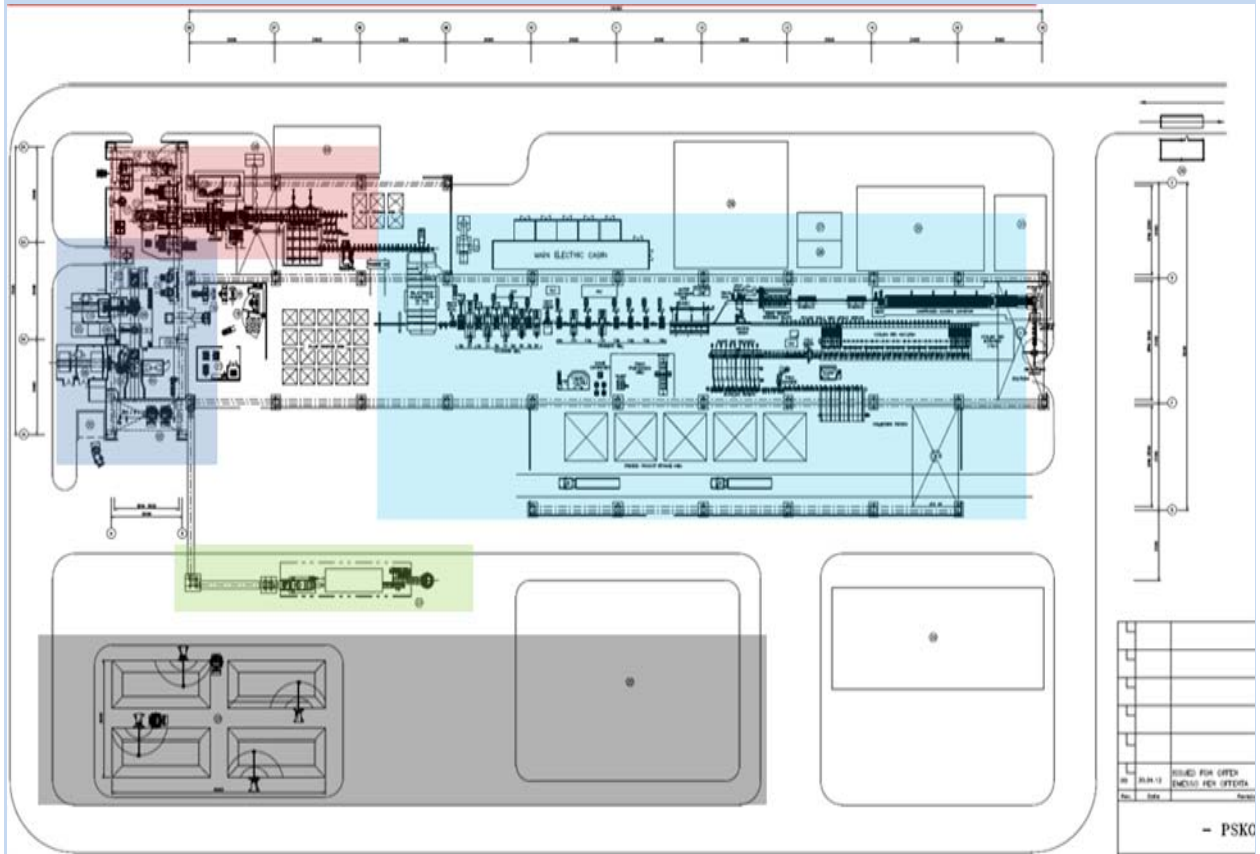

Figure 22. NanoMill 200,000 t/y EAF based / Continuous Rolling Mill.

NANO MILL 100.000t/a Induction Furnace / Semi continuous Rolling Mill

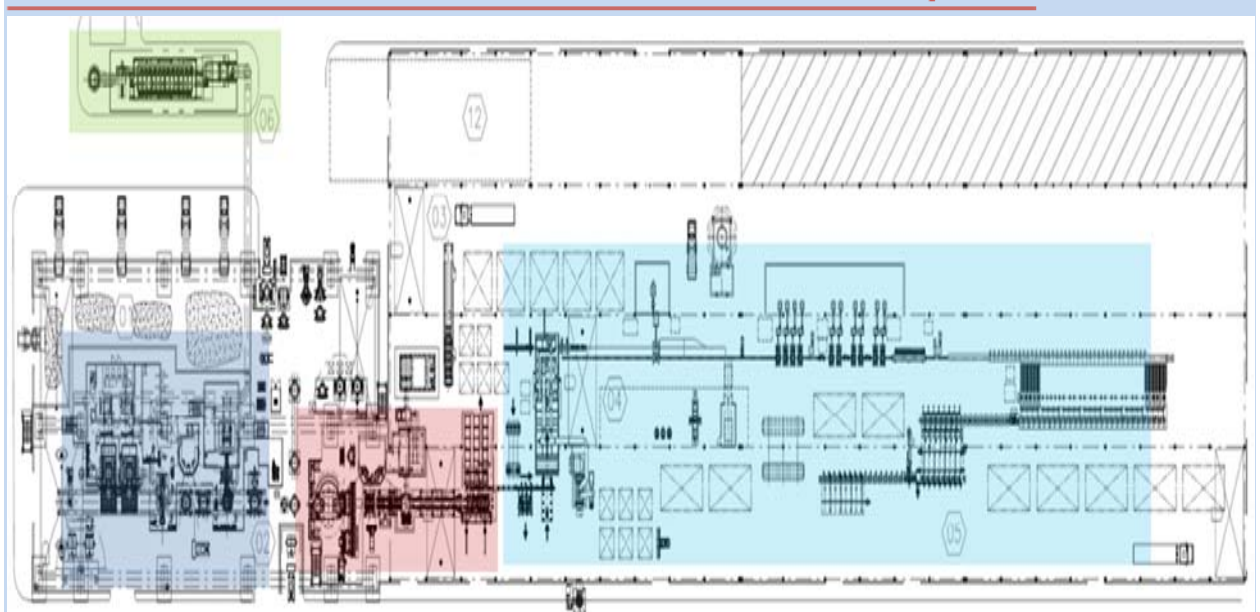

Figure 23. NanoMill 100,000 t/y IF based / Semi-Continuous Rolling Mill.

NANO MILL 300.000t/a Induction Furnace / Continuous Rolling Mill

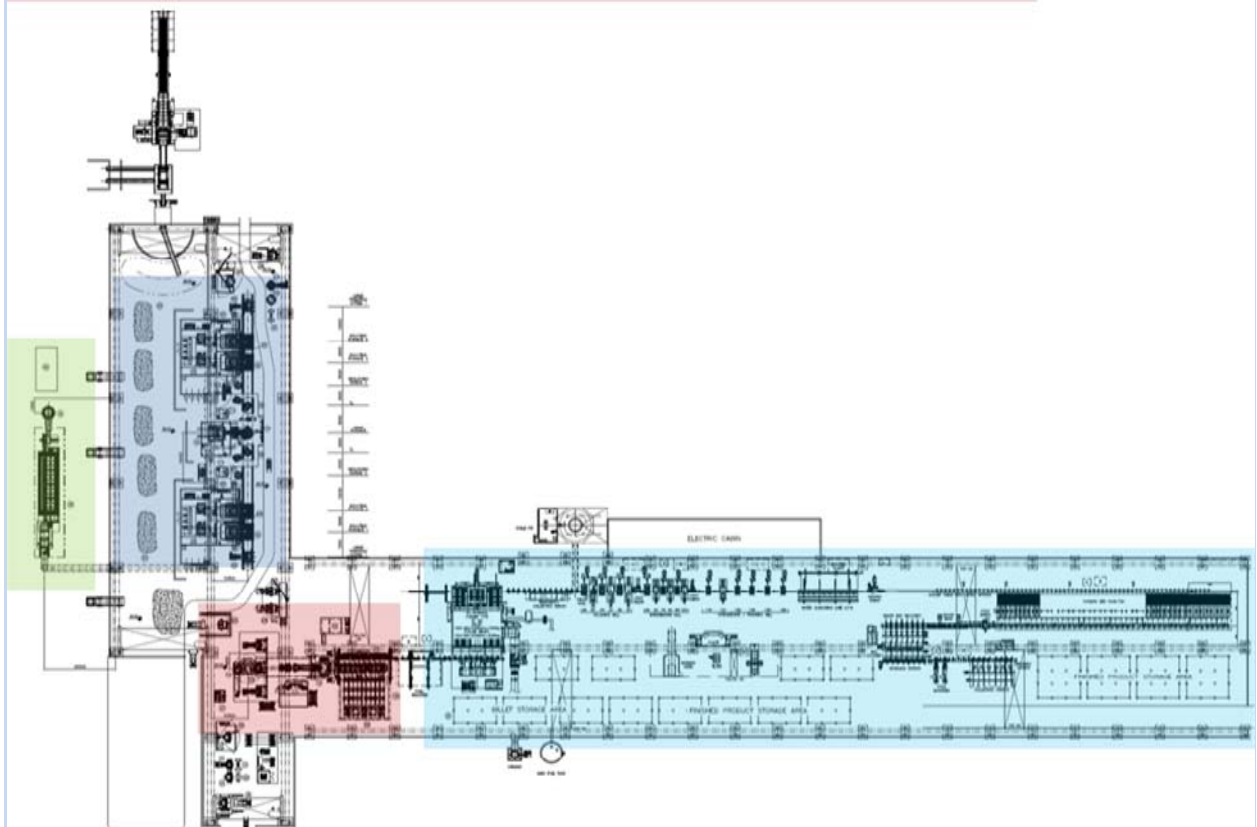

Figure 24. NanoMill 300,000 t/y IF based / Continuous Rolling Mill.

3 CONCLUSIONS

The overall know-how and process integration capability of Danieli provides an additional safety for the investor to be sure that the envisaged capacity of the plant as well as the product quality is achieved.

This know-skill can only be offered by a full line supplier like Danieli, reducing interfaces during the project execution and leading to fast and successful startup of such NanoMill.

Furthermore, the worldwide network of Danieli in all areas of Steel Making, Casting and Shaping provides a fundamental basis for customer support.

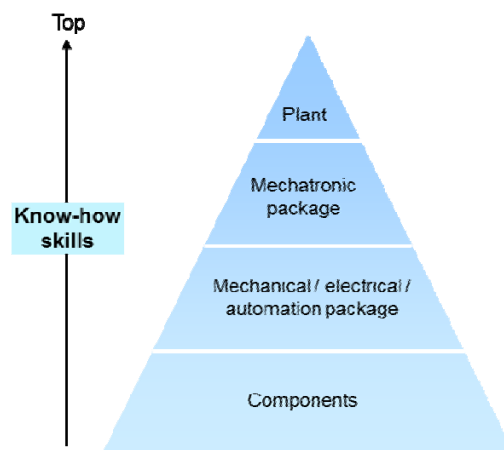

Figure 25. Danieli Know-How

Base on the technological know-how and the knowledge of the market evolution, Danieli is deeply focused in the winning NanoMill strategy, for the best integration of the most advanced technologies to allow our Customers to be competitive and efficient in the Local Market.

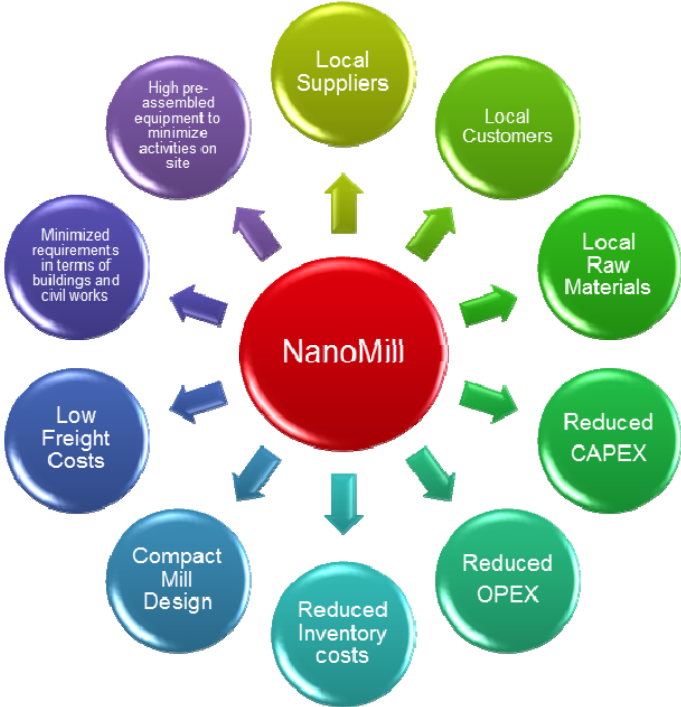

Figure 26. The Strategy of Nanomill Concept.