



## FRICION BEHAVIOUR AND THE STRIBECK CURVE IN RECIPROCATING CYCLES\*

*Eduardo Dominguez Trindade<sup>1</sup>*  
*Amilton Sinatora<sup>2</sup>*

### **Abstract**

Lubricant oils are subjected to reciprocating movement in the piston ring/cylinder tribocouple of automotive engines. In this kind of movement, the relative speed oscillates between zero and a maximum, and therefore the lubrication regime goes from boundary to hydrodynamic. Tribotests are widely used in laboratories to hint at the friction developed in these systems. In the present work, a SRV tribometer was used to evaluate the friction behaviour of lubricant oils under reciprocating movement up to 60 Hz. A high acquisition rate allowed the analysis of data inside each reciprocating cycle. Both a pure base oil and a fully formulated lubricant were used. Changes in the contact pressure, viscosity and speed were seen to influence friction, which was correlated to the relative thickness predicted by Hamrock-Dowson equation. While some observed characteristics were typical consequences of the Stribeck curve, other effects were also observed, such as the occurrence of seizure at high reciprocating frequency. A lower boundary coefficient of friction due to additive package in the formulated oil was also observed. The results allow a better understanding of friction in reciprocating cycles and can be used to evaluate the performance of oils and surfaces in laboratory prior to engine testing.

**Keywords:** Friction; Lubricant; Tribometer; SRV; Stribeck.

<sup>1</sup> *Chemical Engineer, Master of Science in Mechanical Engineering, Research and Development Centre, Petrobras S.A., Rio de Janeiro, RJ, Brazil.*

<sup>2</sup> *Metallurgical Engineer, PhD in Mechanical Engineering, Full Professor, Department of Mechanical Engineering, University of São Paulo, São Paulo, SP, Brazil.*

---

\* *Technical contribution to the 2<sup>nd</sup> International Brazilian Conference on Tribology – TriboBR 2014, November 3<sup>rd</sup> to 5<sup>th</sup>, 2014, Foz do Iguaçu, PR, Brazil.*

## 1 INTRODUCTION

The Stribeck curve is a graphical way of illustrating the different lubrication regimes in a given tribological system. [1-2] Albeit its exact characteristics depend on the system conditions and type of contact (conforming or not conforming), some useful general patterns can be identified. For conforming contacts, the lubrication behavior can be classified in boundary, mixed and hydrodynamic.

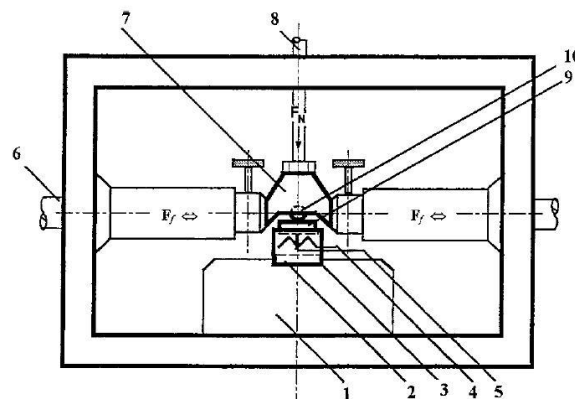
There has been some discussion about what would be the more appropriate quantity for the abscissa of the Stribeck curve [3]. In spite of this, it is generally agreed that the lubrication regime is closely related to the degree of separation between the sliding surfaces. The lambda parameter, which accounts for the relative thickness of the lubricating film, is employed in this way. This parameter can be estimated by Hamrock-Dowson equation as a function of Hertz pressure, lubricant viscosity, speed of movement and surface roughness. [4-5]

Reciprocating movement is found in a series of mechanical systems. In combustion engines, one of the most important reciprocating systems is represented by the piston ring and cylinder tribocouple [6]. One characteristic of such systems is that the movement occurs with variable speed, and thus the exact point in the Stribeck curve is time-dependent within each oscillation cycle. Some work has been done on the understanding of the reciprocating movement in the piston ring/cylinder tribocouple [6-7], but laboratory tests and analyses on this system are not straightforward due to high speeds and temperatures involved.

The present paper aims at the discussion of some friction aspects of the reciprocating movement between a steel lubricated tribocouple and the correlation of these aspects with the Stribeck curve.

## 2 MATERIALS AND METHODS

An Optimol SRV-4 reciprocating machine using ball-on-disc configuration was employed for the tribological tests. The apparatus is described elsewhere [8-10] and depicted in figure 1. The SRV-4 tribometer employed is able to register coefficient of friction data at an acquisition rate of about 50 kHz, thus allowing the investigation of the tribological response of the system within high frequency oscillation cycles.



**Figure 1.** SRV tribometer scheme: (1) receiving block; (2) piezoelectric measuring device; (3) test disc holder; (4) electrical resistance heater; (5) resistance thermometer; (6) oscillation drive rod; (7) test ball holder; (8) load rod; (9) test disc; (10) test ball [xx].

\* Technical contribution to the 2<sup>nd</sup> International Brazilian Conference on Tribology – TriboBR 2014, November 3<sup>rd</sup> to 5<sup>th</sup>, 2014, Foz do Iguaçu, PR, Brazil.



**Table 1.** Viscosity data of the tested lubricant oils

		PAO	Formulated Oil
Kinematic viscosity, mm <sup>2</sup> /s	30 °C	46,7	275
	100 °C	5,99	30,3
Dynamic viscosity, mPa.s	30 °C	38,4	229,6
	100 °C	4,63	23,8

Ball specimens were made of AISI 52100 steel with 700 HV30 and disc specimens were made of AISI H13 steel with 610 HV30. Two lubricants were employed in the present study, a pure polyalphaolefin (PAO) and a fully formulated engine oil. The viscosity of both oils was measured and can be seen on table 1.

All tests were performed at 2.5 mm stroke length. Different loads (ranging from 5 N to 150 N) and reciprocating frequencies (from 10 Hz to 60 Hz) were employed, corresponding to a maximum speed of about 0.47 m/s. The initial hertzian contact pressure was between 0.8 GPa and 2.5 GPa. Tests were performed at 30°C and 100°C.

### 3 RESULTS AND DISCUSSION

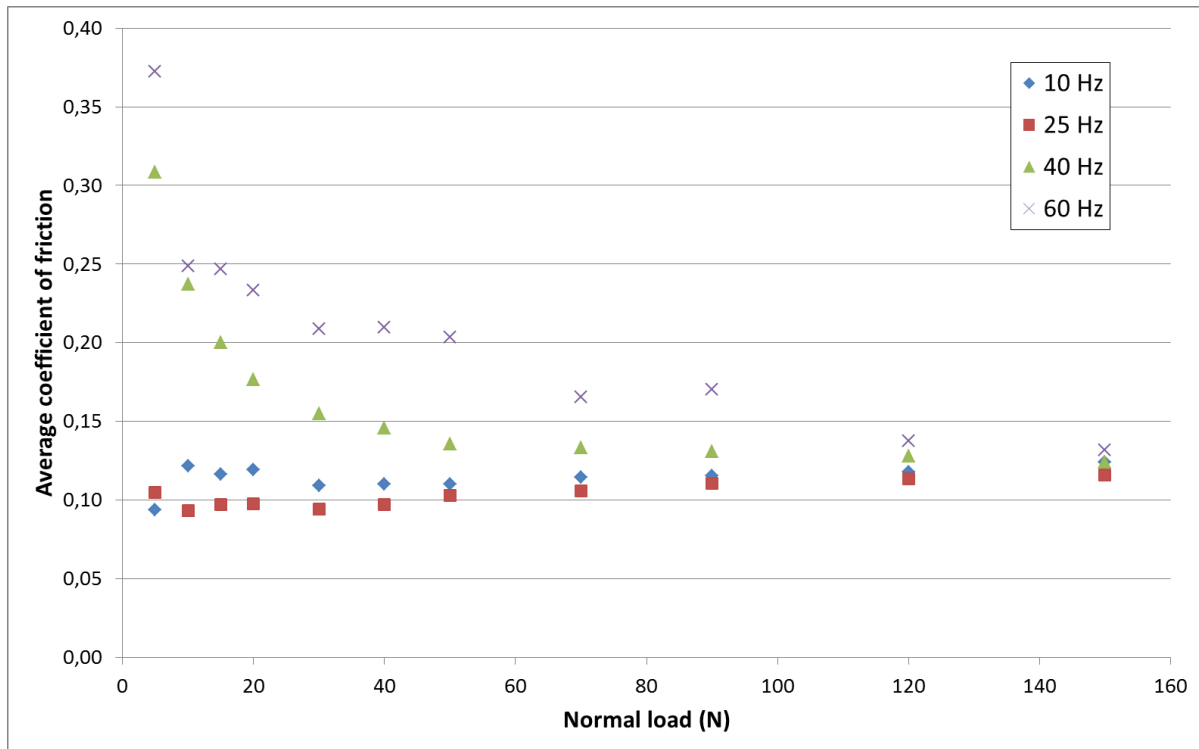
The simplest way of analysing SRV results is through the coefficient of friction average over steady state. In this paper, steady state is considered to happen when there is no noticeable trend on coefficient of friction over the time, what excludes periods of time in which running-in and additives activation take place. On the other hand, the coefficient of friction averaged this way takes into account the entire reciprocating cycle, from minimum (zero) to maximum speed.

Using this approach, figures 2 and 3 show the results for coefficient of friction obtained using polyalphaolefin as lubricant in the SRV test. Figures 4 and 5 show the results obtained with the formulated oil as lubricant.

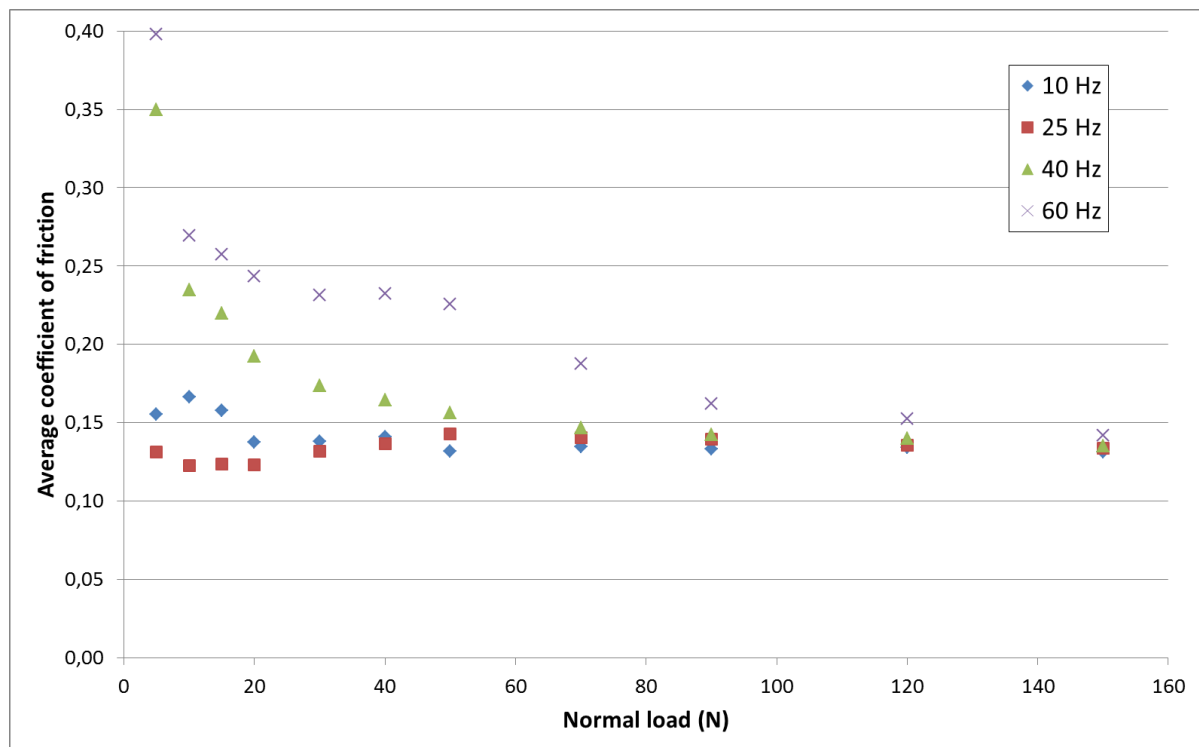
The results indicate a tendency to higher coefficient of friction at higher frequencies and lower loads. They also indicate a tendency to lower coefficient of friction with the use of formulated oil, which was expected due to the presence of the additive package.

With the use of PAO, the temperature has only a very slight effect related to the change in the oil viscosity. On the other hand, the temperature effect is somewhat more pronounced in the formulated oil and is believed to be related to changing in surface equilibrium or additives activation.

\* *Technical contribution to the 2<sup>nd</sup> International Brazilian Conference on Tribology – TriboBR 2014, November 3<sup>rd</sup> to 5<sup>th</sup>, 2014, Foz do Iguaçu, PR, Brazil.*

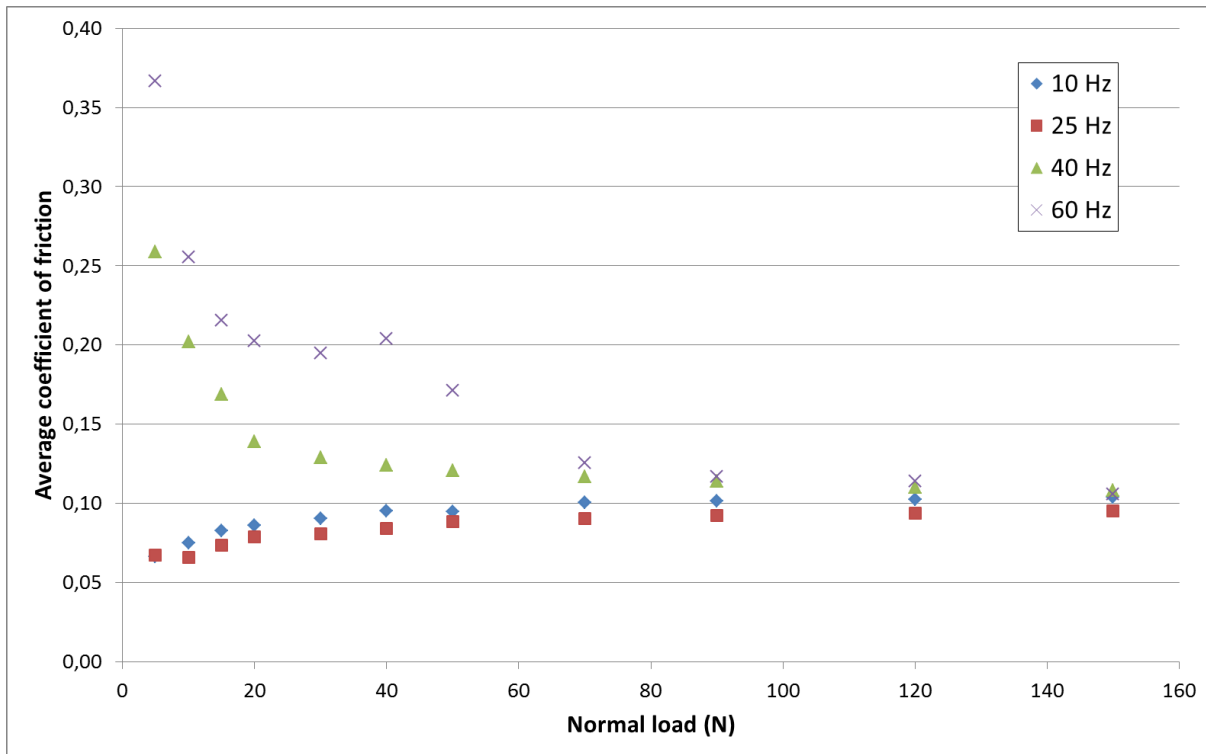


**Figure 2.** Average coefficient of friction obtained with PAO at 30 °C

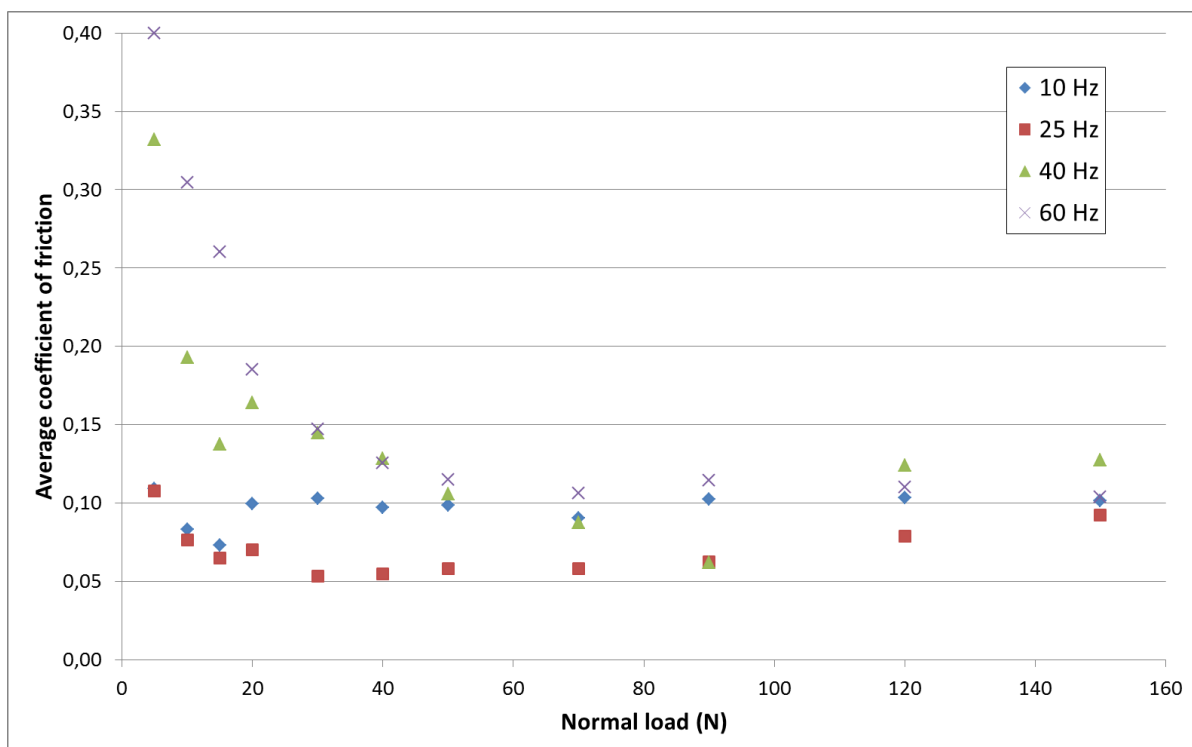


**Figure 3.** Average coefficient of friction obtained with PAO at 100 °C

\* Technical contribution to the 2<sup>nd</sup> International Brazilian Conference on Tribology – TriboBR 2014, November 3<sup>rd</sup> to 5<sup>th</sup>, 2014, Foz do Iguaçu, PR, Brazil.



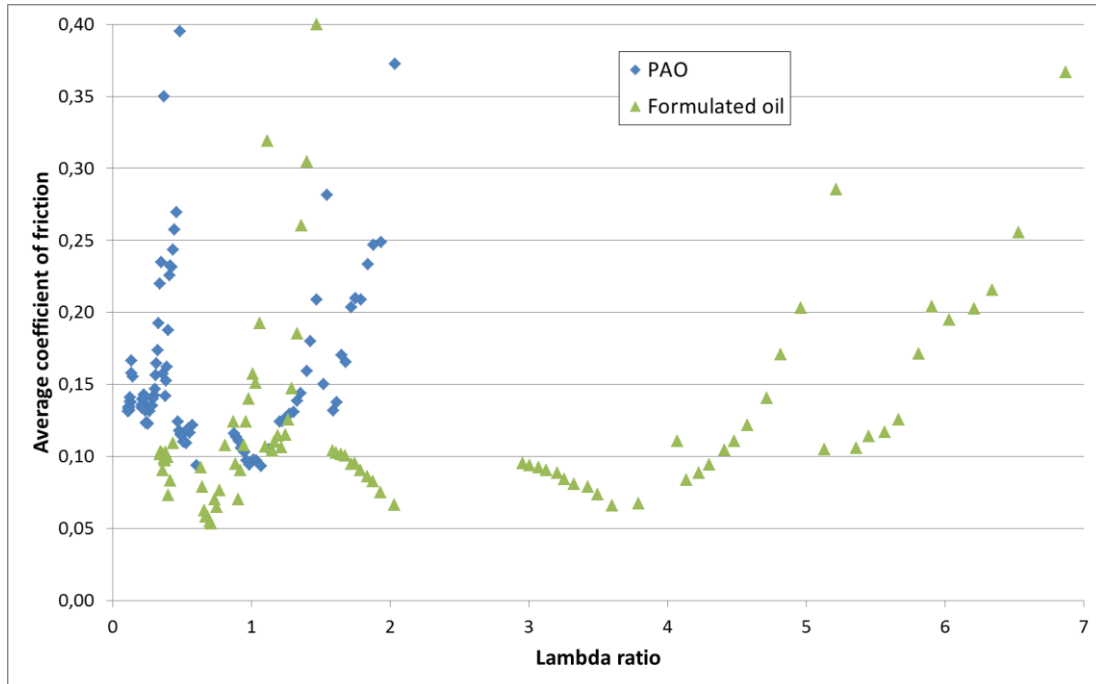
**Figure 4.** Average coefficient of friction obtained with formulated oil at 30 °C



**Figure 5.** Average coefficient of friction obtained with formulated oil at 100 °C

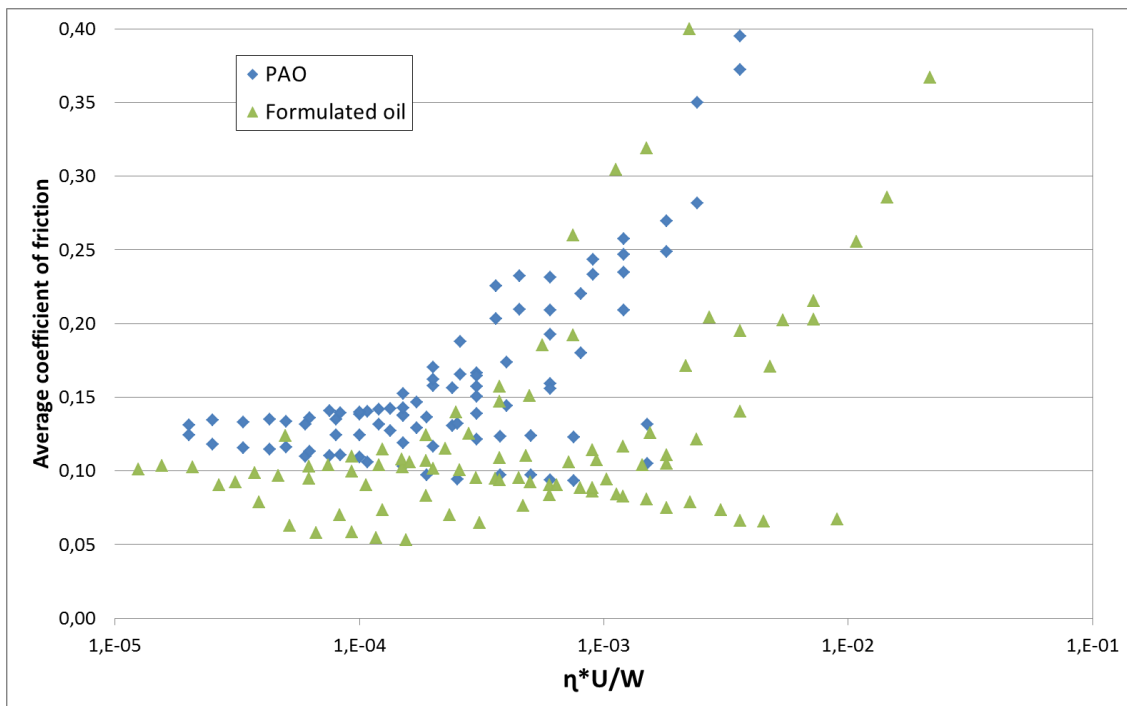
The theoretical lambda ratio for each point of the figures 2 to 5 can be calculated using Hamrock-Dowson equation for point contact using oil viscosity, normal load and average speed as variables. Doing this, it should be possible to draw a single Stribeck curve for each oil. This is shown in figure 6. The result according to the simple analysis is far from expected. It is not possible to correlate data in figure 6 with lubrication regimes; actually, the points do not seem to follow a single tendency.

\* Technical contribution to the 2<sup>nd</sup> International Brazilian Conference on Tribology – TriboBR 2014, November 3<sup>rd</sup> to 5<sup>th</sup>, 2014, Foz do Iguaçu, PR, Brazil.



**Figure 6.** Tentative Stribeck curve for the SRV average coefficient of friction using lambda ratio

A similar approach can be done using  $\eta \cdot U/W$ , where  $\eta$  is the dynamic viscosity,  $U$  is the speed and  $W$  is the load, as the abscissa of the Stribeck curve. Doing this, it is possible to obtain the curves depicted in figure 7. The results still do not show a clear tendency. Instead, a set of different behaviours which do not overlap completely is seen.



**Figure 7.** Tentative Stribeck curve for the SRV average coefficient of friction using  $\eta \cdot U/W$  quantity

The apparently inconsistent results shown in figures 6 and 7 are due to the fact that a traditional, simplest analysis of SRV data lies on an average of coefficient of friction

\* Technical contribution to the 2<sup>nd</sup> International Brazilian Conference on Tribology – TriboBR 2014, November 3<sup>rd</sup> to 5<sup>th</sup>, 2014, Foz do Iguaçu, PR, Brazil.

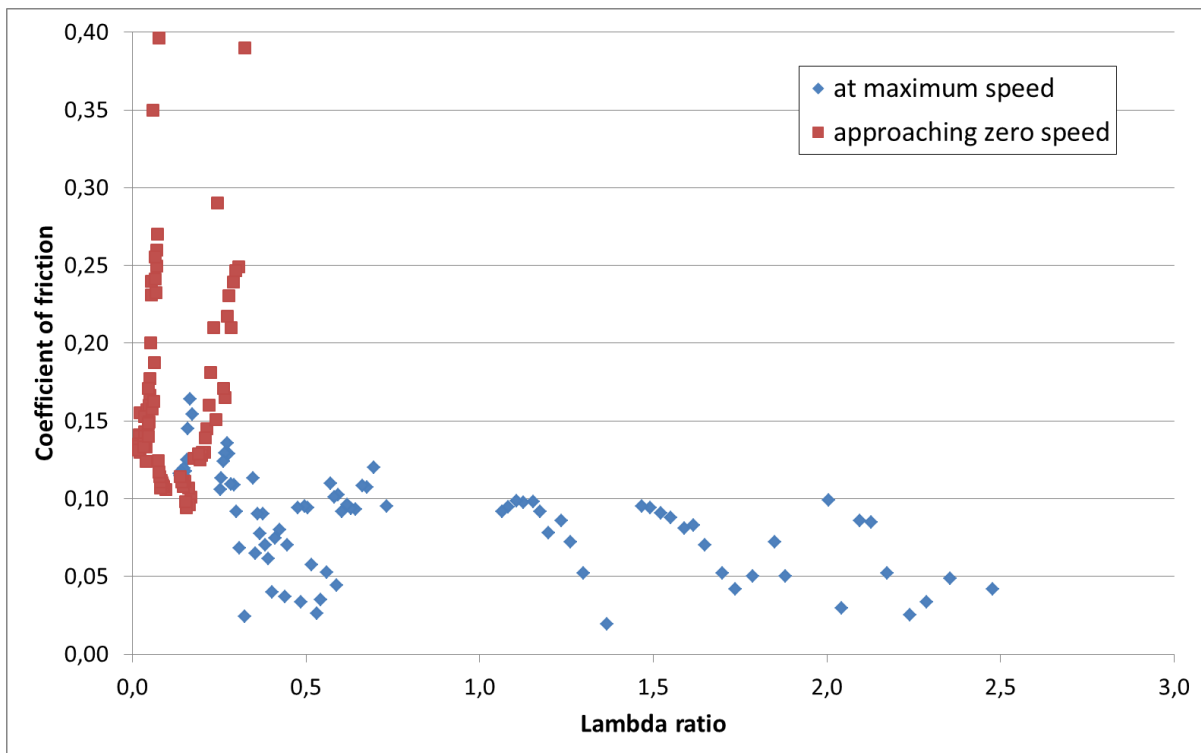


along several reciprocating cycles and not on the actual instantaneous data. A change in reciprocating frequency leads to a change in the fraction of time that the system is subjected to each lubrication regime as well as to a change in the maximum speed and its correlated coefficient of friction.

To solve the inconsistency, one can take a look at actual coefficient of friction values at each point within reciprocating cycles. As a first movement in this way, this paper proposes that each test result should be split in two: one corresponding to the point of maximum speed (halfway between the stroke length) and the other corresponding to a point approaching zero speed (extremes of the stroke length). For practical reasons, as the point of zero speed may correspond to a singularity, in this paper it was considered a point at 1/20 of the full stroke length.

Figure 8 is the tentative Stribeck curve, using the lambda ratio as abscissa, for data collected using PAO as lubricant. A similar curve obtained using formulated oil is depicted in figure 9. The same results are depicted in figures 10 and 11 using the  $\eta \cdot U/W$  quantity as abscissae.

Lambda ratio values shown in figure 8 correspond to boundary and mixed lubrication regimes when PAO was used. Results obtained with the formulated oil (figure 9) have higher lambda ratio due to the higher viscosity of the lubricant.



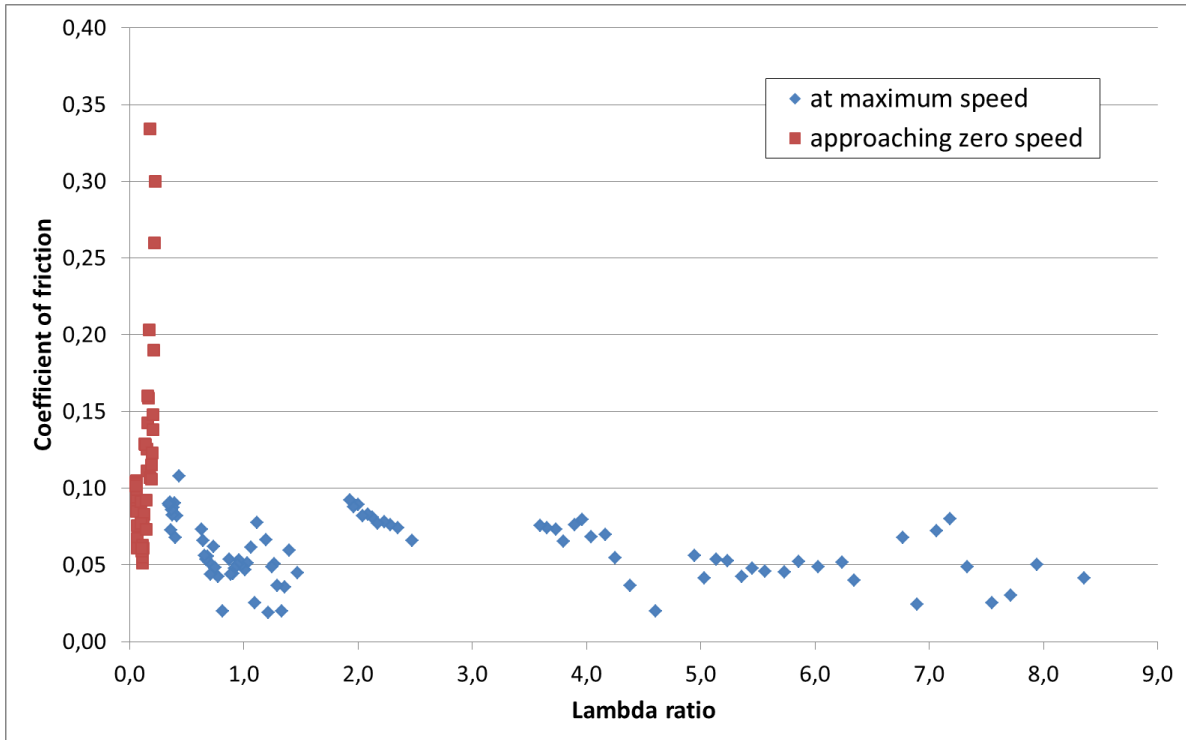
**Figure 8.** Stribeck curve for PAO using lambda ratio

For both the PAO and the formulated oil, two different behaviours can be observed. Unstable values of coefficient of friction above 0.15 (for PAO, figure 10) or 0.13 (for formulated oil, figure 11) were obtained at high frequencies (as can be seen in figures 2 to 5) and near-zero speeds, without correlation with the expected pattern of the Stribeck curve. These points, in fact, can be correlated to the observation of seizure, what was confirmed by the levels of noise during the tests, wear of the specimens and agreement with ASTM criteria. It is interesting to notice that this seizure – breaking of oil film and consequent increase in the coefficient of friction – is determined mainly by the high reciprocating frequency along with low load. The

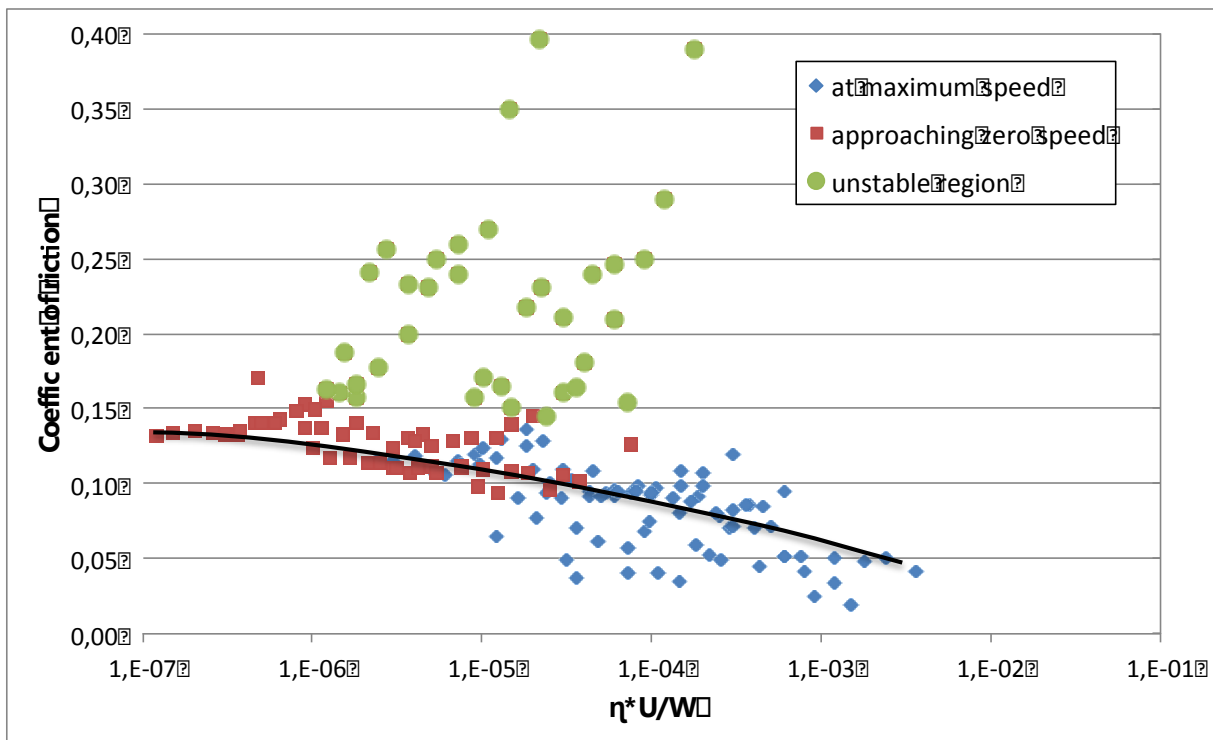
\* *Technical contribution to the 2<sup>nd</sup> International Brazilian Conference on Tribology – TriboBR 2014, November 3<sup>rd</sup> to 5<sup>th</sup>, 2014, Foz do Iguaçu, PR, Brazil.*



change from a lubricated regime to a non-lubricated regime with the increase of the sliding speed is in accordance with the literature [11]. This can be leading to an effect similar to stick-slip, in with there would be some direct contact between steel surfaces conjugated with a force not high enough to move the counterbody. It should be noticed also that the high coefficient of friction figures were observed at low loads, which are a less stable operating region for the tribometer.



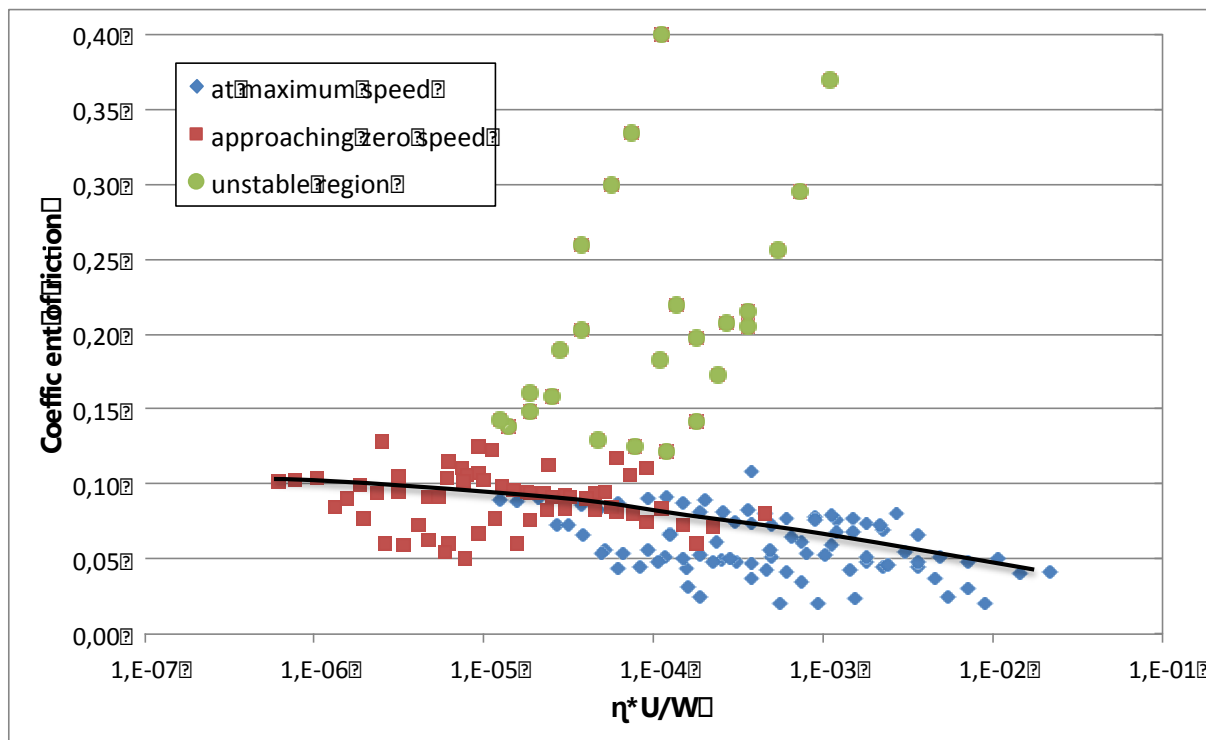
**Figure 9.** Stribeck curve for formulated oil using lambda ratio



**Figure 10.** Stribeck curve for PAO using  $\eta \cdot U/W$  quantity

\* Technical contribution to the 2<sup>nd</sup> International Brazilian Conference on Tribology – TriboBR 2014, November 3<sup>rd</sup> to 5<sup>th</sup>, 2014, Foz do Iguaçu, PR, Brazil.





**Figure 11.** Stribeck curve for formulated oil using  $\eta \cdot U/W$  quantity

A different contact mechanism is observed in the points of lower coefficient of friction. These represent the results of full film lubricated tests and are characterized by a decrease in coefficient of friction with the increase of the contact severity as indicated by  $\eta \cdot U/W$  (figures 10 and 11). Both the condition of maximum speed and the condition near zero speed have a lubrication behaviour consistent with each other, that is, they follow the same trendline. Stribeck curve obtained for the formulated oil lies to the right of that obtained for the PAO as a consequence of the higher viscosity of the formulated oil. As consequence of the effect of the additive package of the later, its Stribeck curve also has lower coefficient of friction in the boundary regime (consequence of friction modifier additive) and a higher dispersion below the trendline (indicating that additive package are not fully effective at every time or contact).

#### 4 CONCLUSION

The SRV tribometer is a powerful laboratory tool for evaluating friction in the ball-on-disc lubricated reciprocating system. It may be taken into account, however, that this system is subjected to an ever-changing speed due to the nature of the reciprocating movement and so an approach relying solely on the average of the coefficient of friction may not be the most appropriate.

Instead, it was possible to draw Stribeck curves for a polyalphaolefinic base oil and for a fully formulated oil based on the instantaneous coefficient of friction measured at different points (and therefore speeds) of the contact. The Stribeck curves calculated using the  $\eta \cdot U/W$  quantity could adequately tell the effects of viscosity (due to changes in temperature or in the lubricant), load and speed for boundary and mixed lubrication.

\* Technical contribution to the 2<sup>nd</sup> International Brazilian Conference on Tribology – TriboBR 2014, November 3<sup>rd</sup> to 5<sup>th</sup>, 2014, Foz do Iguaçu, PR, Brazil.



However, some seizure was observed when higher frequencies (40 Hz and above) were conjugated with lower loads (20 N and below), leading to high, unstable values of coefficient of friction at the turning point (near zero speeds). This led to a clearly different friction mechanism which is not yet fully understood, but can be related to adhesion when the speed approaches zero, associated with tribometer limitations to control and measure system parameters at such conditions.

The formulated oil employed tends to show lower coefficient of friction at the boundary regime.

## REFERENCES

- 1 Jacobson B. The Stribeck memorial lecture. Tribol Int. 2003; 36(1):781-789.
- 2 Dowson D. History of Tribology. 2nd ed. London: Professional Engineering Publishing; 1998.
- 3 Maru MM, Tanaka DK. Consideration of Stribeck diagram parameters in the investigation on wear and friction behavior in lubricated sliding. J Braz Soc Mech Sci. 2007; 29(1):55-62.
- 4 Stachowiak GW, Batchelor AW. Engineering tribology. 4th ed. United States: Elsevier, 2014.
- 5 Hutchings IM. Tribology: friction and wear of engineering materials. London: Edward Arnold Publishers Ltd., 1992.
- 6 Andersson P, Tamminen J, Sandström CE. Piston ring tribology: a literature survey. Espoo: VTT, 2002.
- 7 Tomanik E. Modelamento do desgaste por deslizamento em anéis de pistão de motores de combustão interna [thesis]. São Paulo: Universidade de São Paulo; 2000.
- 8 ASTM International. ASTM D6425-05: Standard method for measuring friction and wear properties of extreme pressure (EP) lubricating oils using SRV test machine. West Conshohocken: ASTM International, 2010.
- 9 ASTM International. ASTM D7421-11: Standard test method for determining extreme pressure properties of lubricating oils using high-frequency, linear-oscillation (SRV) test machine. West Conshohocken: ASTM International, 2011.
- 10 Trindade ED, Zuleta Durango A, Sinatora A. Friction and wear performance of MoDTC-containing and ester-containing lubricants over steel surfaces under reciprocating conditions. Lubr Sci. In press. DOI: 10.1002/ls.1270
- 11 Gee AW, Begelinger A, Salomon G. Failure mechanisms in sliding lubricated contacts. In: Mixed Lubrication and Lubricated Wear. Proceedings of the 11<sup>th</sup> Leeds-Lyon Symposium; 1984, Leeds. United Kingdom: Butterworths, 1985.

---

\* Technical contribution to the 2<sup>nd</sup> International Brazilian Conference on Tribology – TriboBR 2014, November 3<sup>rd</sup> to 5<sup>th</sup>, 2014, Foz do Iguaçu, PR, Brazil.