

# MODERN RAIL ROLLING TECHNOLOGIES<sup>1</sup>

Luigi Giacomini<sup>2</sup>  
Alberto Lainati<sup>3</sup>

## **Abstract**

In several areas of the world, the production of rails is increasing due to the interests generated by the market for high-speed or/and high-load railways. The quality requirements are demanding, and rolling processes and technologies must adapt to the new challenges in order to provide rollers with efficient and profitable plants. Whereas driving factors for rail end-users are “faster, heavier, longer, durable”, the answer from rail producers must be “consistent, reliable, performing, flexible”. This paper presents some of the innovations developed by Siemens in the field of rail production, including EVO rolling stands, idRHa+ head-hardening system and EVO pre-cambering technology.

**Keywords:** Rail; Rolling; Cost-effectiveness; Head-hardening.

<sup>1</sup> *Technical contribution to the 50<sup>th</sup> Rolling Seminar – Processes, Rolled and Coated Products, November, 18<sup>th</sup> to 21<sup>st</sup>, 2013, Ouro Preto, MG, Brazil.*

<sup>2</sup> *Market Communication, Siemens Metals Long Rolling*

<sup>3</sup> *Head of Technology, Siemens Metals Long Rolling*

## **1 MARKET SCENARIO AND REQUIREMENTS**

The market for new railroads and the modification of existing lines has become increasingly active during the recent year. Its cost-effectiveness and relative ease of operation for short to medium distances, make railway transportation a convenient way for both freight and passenger transportation.

Among the worldwide investments worldwide announced or known during the first half of 2013 there are:

- Mexico to spend \$24 billion in infrastructure, including railways
- Russia Russian Railways posed to consume 1,000,000 tpy of rails
- Britain to make the biggest rail investment in more than 100 years, with £30 billion in 2014-2020
- California High-Speed Rail Authority okayed by Transportation Board for a new line
- Brazil launched a rail package in 2012 which foresees R\$91 billion expenditure for 10,000 km of railways

## **2 KEY REQUIREMENTS OF MODERN MILLS**

In the field of passenger transportation high-speeds (over 200 km/h) are requested, which can make rail transport very competitive and practical against air transportation over short to medium distances. Today, railway cruising speeds exceeding 350 km/h are not uncommon. On the other hand, freight transportation is calling for large load capability. Long freight trains with more than one hundred cars (the "mile train") are not uncommon for commodities like minerals and crops, while the individual axle load has been increasing from the conventional 25 tons to heavy haul 40-50 tons.

Both high-speed and heavy haul transportation call for premium grade rails, where strict quality requirements are met. Wear resistance, rolling contact fatigue, vibrations, dynamic loads and rail linear tolerances are just some of the issues that have to be addressed. Rail operators therefore want high-quality rail solutions that are flexible and that help increase operational profitability. The answer lies in modern rail production facilities that offer high operation flexibility, accuracy, efficiency and quick change of production with minimum downtime.

A modern installation for rail rolling must be able to address all market requests, for both freight and passenger railways application. There is an intensive research to improve the rail performance, improving the features of existing steel grades and microstructures, as well as developing new ones. In the field of freight or mixed freight-passenger railways, the most common microstructure is non-alloyed low strength pearlitic steel. Since the requirements of high resistance to wear and contact fatigue are increasing, pearlitic steels are being further improved, while new alloy-grade rails with bainitic or pearlitic/bainitic structures are being developed (Figure 1).

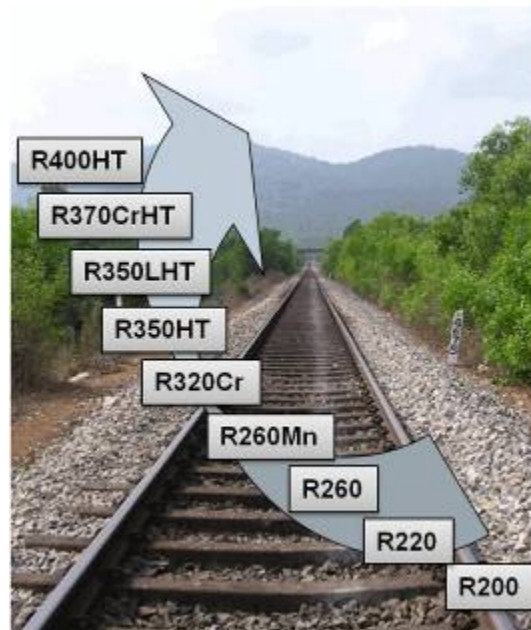

**Figure 1.** Trend of steel grades for rails.

There are several major process technologies nowadays available to produce rails. The rail manufacturers want to be flexible and reactive enough to quickly respond to changes in the market scene, while maintaining a profitable operation. Therefore, they must have a plant apt to the efficient production of a wide range of grades-sizes-lengths with quick automatic setup operations, self-adaptability of use, intelligent process control system and sustainable costs.

In particular, rail manufacturers want to:

- cater to all rail market segments, and fulfill all international rail standards
- improve the product quality and the operation reliability
- reduce the operational costs
- be capable in some cases to roll also sections, typically medium (up to 300 mm) or large sizes, e.g. beams and channels.

With the integration of modern automation and process technologies which are applied to a rail mill, premium products can be obtained, with tight linear tolerances, consistent metallurgical and mechanical features and higher selling price.

### **3 ROLLING MILL LAYOUT**

For mills that produce rails only or rails and sections up to 300 mm, the state-of-the-art layout is composed of two EVO reversing breakdown mills (BDM), a 5 to 7-stand continuous universal mill, an in-line heat-treatment process, a cooling bed with a pre-cambering system, a straightening system, and ancillary systems such as sawing units, hot marking, stacking and binding, and control systems.

With this type of configuration, rails up to 120 m in length may be rolled continuously. For mills that produce rails and heavy sections over 300 mm the most practical layout (Figure 2) is a EVO breakdown mill (BDM) followed by a 3+1 tandem intermediate and finishing universal mill.

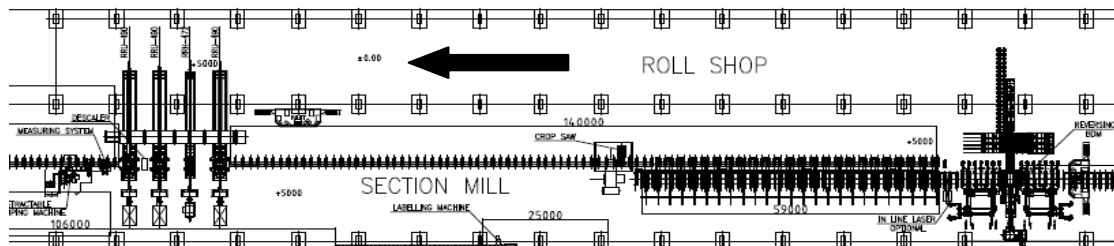

**Figure 2.** Layout with breakdown mill and 3+1 Tandem Intermediate and Finishing Universal Mill.

### 3.1 Reversing EVO Breakdown Stands

Whether the initial feed material is solid bloom/billet or a form-cast blank, it is first descaled and then rolled through a reversing EVO breakdown mill (Figure 3) down to the necessary leader pass shape. The reversing EVO breakdown offers the possibility of applying a sufficient reduction ratio required for finishing rolling.



**Figure 3.** Reversing EVO breakdown stand.

EVO breakdown stands typically offer roll diameters of 600 mm to 1400 mm and side-guard manipulators. In the case of rail mills, the typical roll working diameter is 800 mm to 1,000 mm, with a barrel length of approximately 2,000 mm. In case of two breakdown stands, the rolls are identical to minimize spare components. An optimum setup also includes hydraulically balanced rolls, electric motors to adjust the gap, transducers, and load cells. Four-row taper roller bearings support radial loads, and two-row thrust taper roller bearings support the axial load. With free-floating chocks the distribution of the load on the bearings is more uniform, so their life is extended and maintenance stoppages are reduced. The quick-change car device allows for the stand holder with worn rolls to be quickly removed and replaced with the new rolls. Hydraulic capsules on the bottom roll are used for roll wear compensation and anti-jamming. Despite its relatively large size, the whole mill has a compact design to that deformation is kept within very small limits. The development of automation protocols enable modern generations of EVO breakdown mills to operate with a high degree of automation, with minimal human intervention; this guarantees a consistent product quality while ensuring the highest safety to both personnel and components.

The reversing breakdown mill does not require large foundation works if compared with the old 3-Hi design, and tilting roller tables are not necessary, which results in a compact installation. Modern inverter-driven variable speed motors make the rolling speed control easier, while at the same time minimizing the energy consumption.

### **3.2 Continuous Finishing Universal Mill**

The universal mill reduces the leader pass to the final rail shape through a sequence of continuous passes using five to seven universal/horizontal Red Ring stands. This allows for a fast and easy conversion between universal and horizontal configuration. The same configuration may be adopted for sections up to 300 mm.

The continuous finishing universal mill is advantageous for:

- High production rates
- High reliability of rolling process (off-line stands are preset)
- Smooth rolling process with less equipment maintenance
- Perfect rail shape control (one edging pass after each universal pass)
- Better control of roll wear, longer roll life and fewer roll changes
- Less heat losses of rail with lower power consumption and better tolerance
- No need to change stand as line is set up after each pass
- Reduced downtimes for stand changes with a quick-change device.

### **3.3 3+1 Tandem Intermediate and Finishing Universal Mill**

The most modern concept applicable to installation which produce large sections and rails is the 3+1 tandem intermediate-finishing mill, which is composed by four stands closely arranged. The intermediate group is composed by three stands arranged in configuration Universal-Horizontal-Universal, which operate in reversible mode. It is immediately followed by a single pass universal finishing stand. The key advantage of this configuration lies in that the fourth stand is kept open (or off-line) during reversing intermediate rolling in the first three finishing stands, and it is closed (or moved in-line) only to apply the final single finishing pass. As the reduction applied during finishing is very small, the rolling stresses and the consequent wear of the rolls are limited, which allows a longer useful life of the rolls with fewer required roll changes. This has a beneficial impact on the productivity. In a 3-stand universal configuration where the final stand is used for both reversing and finishing rolling, the lifetime of its rolls would not normally exceed 1,000 tons, depending on the bar size, in order to maintain an acceptable quality of the finished bar. With the 3+1 tandem solution, the rolls duration in the final stand is expected to reach 2,000-3,000 tons. Now, as commonly rolled campaigns for rails and sections are in the average size of 2,000-2,500 tons, changes of finishing stand during the campaign become largely unnecessary. The reduction of required changing stops with the consequent increase of hours availability (up to 4%) lead to an increase of productivity which corresponds to 5% in case of a nominal yearly value of 1 million tons, which rapidly pays off the cost of the additional stand. For the same reason, despite the additional stand, the total number of rolls in the warehouse does not significantly increase. The technological features of the 3+1 tandem mill make use of state-of-art automation. The under-load gap hydraulic adjustment is derived by the flat rolling technology and the fully automated stand change protocol reduces the total change time to less than 20 minutes, while improving the safety conditions. The overall footprint required for

the installation of the 3+1 tandem is also limited, as the fourth finishing unit is located immediately after the reversing stands.

#### 4 INTRODUCTION TO idRHa+\* TECHNOLOGY FOR RAIL HEAD HARDENING

The requested performances of trains have shown an upward trend during the recent years. While passenger lines cruising at over 200 km/h are increasingly common, the maximum load of freight cars has significantly increased. Particularly in case of minerals and crops transportation, axle loads may well be in excess of 35 tons and the length of the freight trains is sometimes surpassing the one hundred freight cars (the so dubbed "mile train"). It is evident how crucial it is to increase the properties of the rail contact area, i.e. the rail head, where the contact with the rolling wheel takes place. This may be reached by a proper combination of hardness of the outer rail head surface, with a good tenacity of the head core, so to be able to withstand impact loads as well. This is particularly obtained controlling the percentages of decomposed austenite in the outer and inner parts of the rail head (Figure 4).

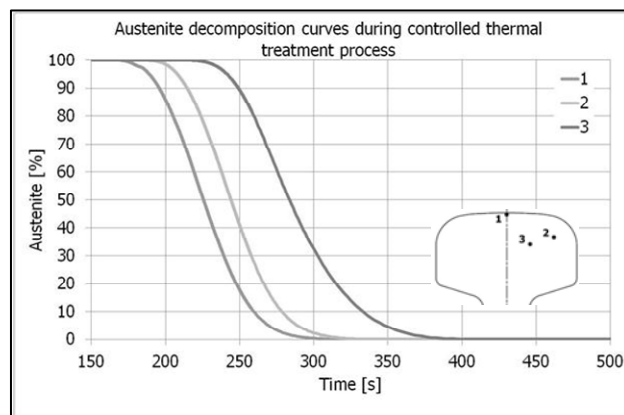

**Figure 4.** Controlled percentages of austenite with thermal treatment.

The service life in the track and switch systems is especially determined by rolling contact fatigue (RCF) that can generate surface damages e.g. cracks, which over time impair the functional properties of the rail. Damage removal actions (grinding, refurbishing) are lengthy and costly operations. In order to extend the rail service life, it is necessary to improve the RCF resistance.

Currently, about 80% of world rail market is served by standard rails, i.e. grades with a predominant low-strength pearlite microstructure, with an ultimate tensile strength (UTS) below approximately 1,000 MPa (Figure 5).

---

\* (*idRHa+* is a registered trademark of Siemens AG and/or one of its subsidiaries)

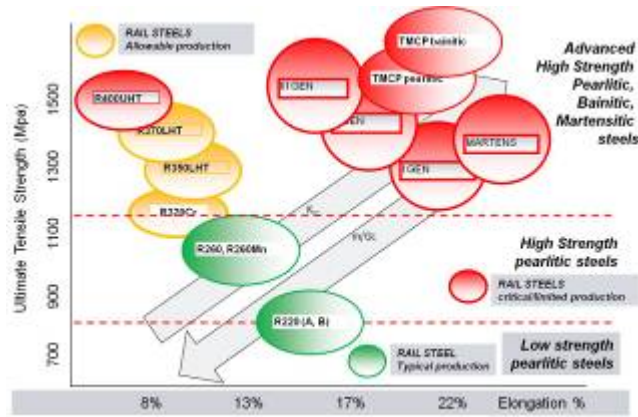

**Figure 5** UTS and elongation of rail steels.

As higher values of UTS are conducive to improved RCF resistance, stronger rail materials have been and keep being developed. In pearlitic rail steels, UTS is increased by reducing the spacing between the cementite lamellae, which may be obtained by adding costly alloying elements to the chemistry or through head-hardening. While the development of pearlitic rails seems to have somehow reached its limit, bainitic rails show superior qualities in terms of RCF resistance and are excellently performing in heavy haul railroads, with its market share increasing. The initiation time of RCF damage is longer in bainitic rails, and it may be further prolonged with an increase of UTS (up to approximately 1,500 MPa), which may be obtained with heat treatment. Therefore, with both pearlitic and bainitic (or combination of the two) microstructures, UTS values may be increased by suitable heat treatment (head-hardening).

Precisely on these grounds, Siemens decided to take the state-of-the-art technology one step forward with the Induction Dual Phase Rail Hardening (idRHa+) process, developed in cooperation with Centro Sviluppo Materiali (CSM). Based in Italy and internationally renowned, CSM is a leading industrial research and technical center, highly qualified in the steel manufacturing field, with many years of experience in material research and process development. idRHa+ process was developed through the extensive use of integrated numerical modeling, whose soundness was checked and validated through an extensive set of experimental trials in the pilot unit built in CSM laboratories (Figure 6).



**Figure 6.** Pilot unit at CSM laboratories for validation trials.

Currently, it offers the most flexible and advanced operation, its strongpoint with easy adaptation to different layouts and routes, production rates, material and cooling requirements (Figure 7).

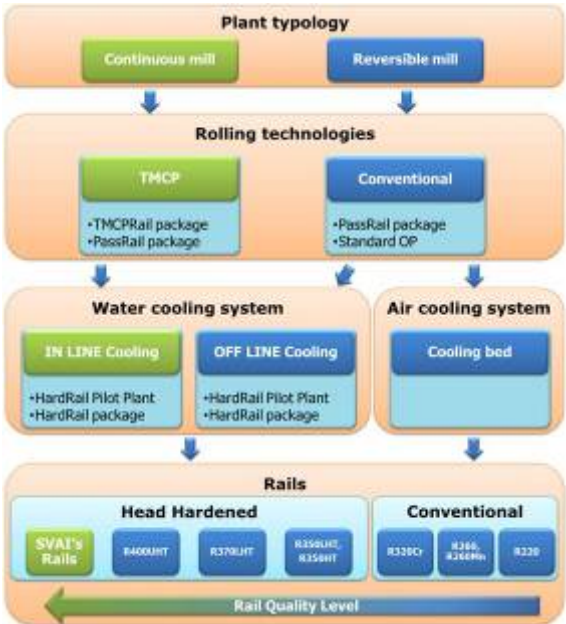

Figure 7. idRHa+ adapts to different production routes.

idRHa+ is the most advanced rail head-hardening system currently available, its main strengths being its outstanding process performances and the easy adaptation to different conditions (layout, production rates, material and cooling requirements). idRHa+ lays its foundation on a comprehensive concept, which considers all the aspects of the production lifecycle of the rail, and models them with thermal, mechanical and metallurgical numerical simulations; the results are validated by true-trials in an industrial pilot unit. Modeling allows the precise control of the cooling process around the rail outer profile to obtain the desired microstructure and hardness distribution across the rail section. This approach allows rail rollers to accompany the whole process simulation, and test in advance rail samples through different cooling models, so that the head-hardening line can be quickly ramped to nominal production, and its performances obtained with full consistency and reliability.

**5 idRHa+ FEATURES AND OPERATION**

The first zone of idRHa+ is equipped with the induction heating system, which serves for the selective adjustment of the rail temperature after rolling. The temperature is equalized along the rail longitudinal dimension, while the desired temperature gradients may be obtained across the rail transversal section. (Figure 8).



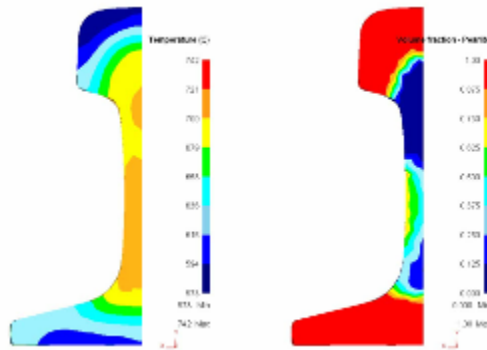

**Figure 8.** Control of section temperature gradients.

The system is capable to heat the rail from ambient temperature in case of off-line application. The heating system consists in a series of high-power induction modules, with split top and bottom coils powered by individual digital phase converters (IGBT). The number and location of the heating units depend on productivity, rail sizes and grades, while the total installed power is 30÷35 kW per t/h of rolled rails. Their design grant an efficient transfer of high power density to the rail in short times and spaces. The cooling zone of idRHa+ contains several modules (Figure 9), each equipped with a set of interchangeable cooling devices (spraying nozzles with mist-atomizers of different media or air-jet blades) which apply the required cooling protocols.



**Figure 9.** idRHa+ cooling area.

Depending on the processed grade, the surface rail temperature is normally 750÷1,000°C at the entry and 300÷650°C at the exit, with the cooling speed adjustable in the range of 0.5÷40°C/s (Figure 10) in accordance to the required microstructure and mechanical characteristics.

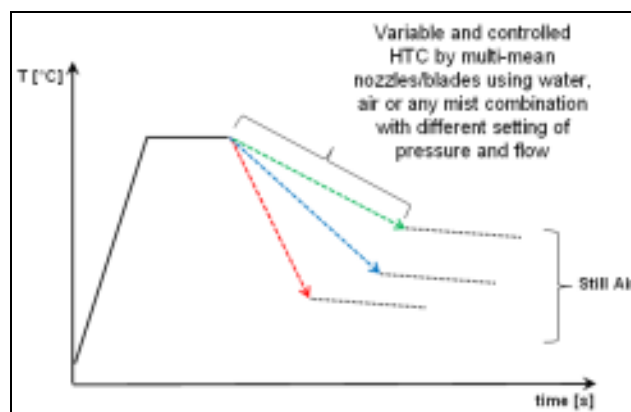

**Figure 10.** Adjustable cooling speed by idRHa+.

Temperatures are continuously monitored by pyrometers or thermo-scan cameras, and are used by the process control system to apply the fine regulation of:

- selective use of cooling modules
- cooling media pressure and flow rate values
- distance of spraying nozzles
- rail running speed

in order to correct dynamically any recognized thermal heterogeneity along the rail length and across the rail section.

Each module may be stand-alone operated and controlled, or else coupled with one or more others. Pre-set process protocols, with heating and cooling rates and temperature profiles, are stored in the process control system as function of grade and characteristics.

Embedded in the process control system are also several thermal, mechanical and metallurgical models, like e.g. austenite decomposition with microstructure prediction, precipitation behavior, thermal evolution with transformation heat calculation, mechanical properties prediction, deformation behavior. Through the application of the process models, the control system manages and predicts the process and the product parameters according to:

- actual chemistry
- desired microstructure
- desired mechanical characteristics, like hardness and strength
- hot rolling mill setup and procedures (e.g. stand layout, thermo-controlled rolling)
- expected temperature in defined profile points (head, web and foot) and along the length (head, center, tail)
- expected austenite decomposition rate and transformation temperature.

The pre-set cooling strategy is then fine-tuned taking into account the actual parameters, measured or predicted with integrative data during the rail process route. The use of the most suitable cooling mean and its working parameters (e.g. pressure, flow rate) are determined for each module according to the optimized process strategy suggested by the process models. Once validated, the process protocols are stored in the control system for easy recipe-management.

This guarantees the active application of an ideal cooling path along the whole rail length and across the whole cross section. Very strict characteristic variation can be obtained avoiding formation of zone with too high or too low hardness and avoiding any undesired microstructure.

idRHa+ may process rail sizes up to 75 kg/m, including asymmetrical. While idRHa+ is expected to deliver unsurpassed performances in terms of flexibility and reliability for seamless rails up to 120 m length, its flexibility it may also be adapted to process shorter lengths in both in-line and off-line applications. As of July 2013, two contracts including the supply of idRHa+ process and equipment are in force (China and Kazakhstan).

## **6 GAUGING AND INLINE INSPECTION**

The rail profile is continuously monitored before the rail enters the cooling bed, using a ProScan Optical Profile gauge (Figure 11).

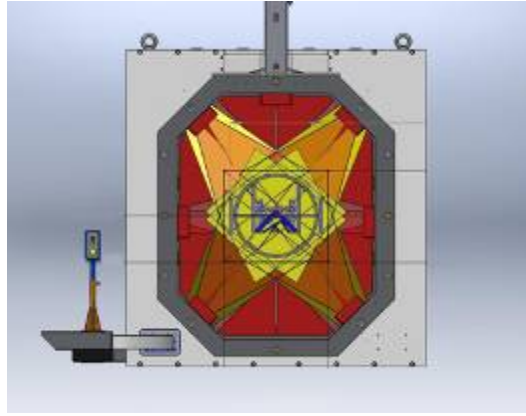

**Figure 11.** ProScan Optical Profile gauge.

ProScan is a static gauge which uses 2-D cameras and lasers to determine the profile with a typical accuracy of  $\pm 0.1$  mm. The measured data allow for the automatic adjustment of rolling parameters and can automatically spot surface defects. ProScan may be effectively complemented by a surface Defect Detection module which reads the temperature differential of the edges of the defect. The module is enclosed in the ProScan body, and is capable to detect all surface defects such as rolled-in scale, well defined dents and scratches.

## **7 PRE-CAMBERING OF RAILS**

In some cases, mainly depending on rail temperature, grade and shape, during cooling on the bed the rail will show a marked tendency to bulge outward on its head side. If this bending effect is too large, the subsequent straightening process becomes too difficult, and with excessive stresses on the rail and the straightening equipment itself. This may result critical especially for long rails (over 100 m), like those employed in high-speed passenger railways, which have very tight requirements of straightness and residual stress.

To prevent this occurrence, the EVO pre-cambering system applies an opposite inward bend on the rail at the entrance of the cooling bed, by means of active cars with hydraulic grippers (Figure 12).



**Figure 12.** EVO pre-cambering system.

Each car travels for individually programmable distances that allow for the application of different pre-camber patterns. The pre-camber patterns are calculated by cooling numerical models for different rail parameters and validated by experimental trials.

EVO pre-cambering allows the rails to be sufficiently straight when entering the straighteners to reduce the straightening force and residual stresses.

## 8 STRAIGHTENING SYSTEMS

High-speed trains call for extremely tight tolerances of linearity and rail shape, and low levels of internal residual stress. Before entering the straightening area, a hydraulically operated manipulator positions the rail onto its foot and ensures entry to the straightening machines.

The typical straightening line for rails (Figure 13) is composed of horizontal and vertical straightening machines within a rigid frame containing two staggered rows of rollers.

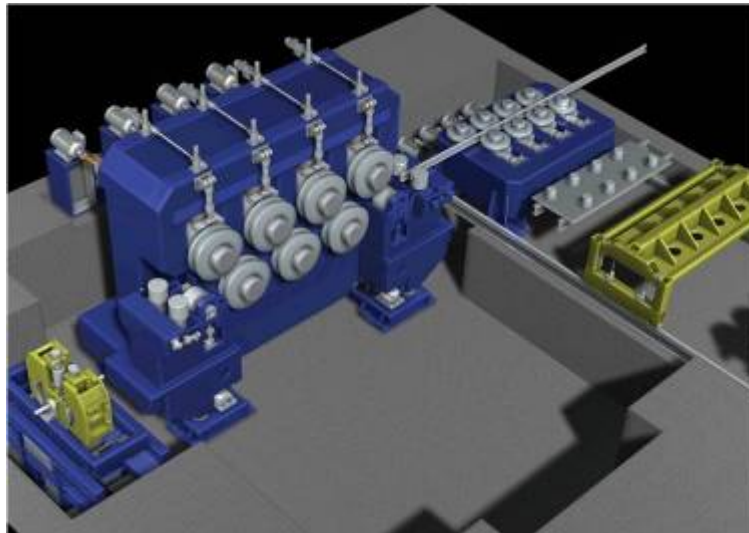

**Figure 13.** Rail straightening area.

The roller position and centerline is adjustable according to the rail size and its section modulus, and hydraulic counterbalance eliminates backlash. The rollers are mounted in a removable cassette for quick changing so that the cassette can be automatically removed and replaced with a standby cassette. A suction system removes the scale.

The state-of-art straightening technology employs hydraulic capsules, which significantly benefits the compactness of installation and speed of under-load roll regulation.

## 9 SAWING EQUIPMENT

Sawing (Figure 14) is preferred to shearing to achieve the desired length for hot-cut rails. Sawing eliminates the deformation of rail ends and obtains better cut quality and precision. Depending on factors including noise limitation and campaign duration, either metallic or abrasive hot saws can be used. During sawing, the rail is clamped at both sides of the wheel, whose movement can be either pendulum or linear. The metallic disc sawing equipment is encased in a sound-proof cover. For abrasive cut the wheel wear is automatically compensated by adjusting the approach stroke while its peripheral speed maybe maintained constant by the inverter-driven motor. Saws are used for nose and tail cropping and sampling, with automatic crop and sample discharge systems. As swarf is collected in a bin, a separate dust

removal and filtering system is provided with abrasive sawing equipment. The final cut-to-measure of the rail is done by saw with cementite carbide inserts, and may be integrated with the drilling station.



**Figure 14.** Metallic disk saw.

## **10 CONCLUSION**

Rail production is increasing in quantity and improving in quality, due to the interest generated by high-speed or/and high-load railways. Rail rollers must answer the new demanding quality requirements with modern rolling processes and technologies, so to be able to run efficient and profitable operations. Some of the innovations developed by Siemens in the field of rail rolling have been presented in the paper. In particular, the head-hardening process idRHa+ represents the state-of-the-art in terms of flexibility and quality. As of July 2013, two contracts including the supply of idRHa+ process and equipment are in force (China and Kazakhstan).

## **BIBLIOGRAPHY**

- 1 I.Hlavaty, "The Bainitic Steel for Rails Applications" ( 2009)
- 2 J.Hogg, L.Giacomini, "Modern Solutions for Rail Rolling" (2011)
- 3 A.Lainati, F.Pegorin et al., "Rail rolling plants: innovative process for future trends" (2013)
- 4 K.Mädler, A.Zoll, R.Heyder, M.Brehmer, "Rail Materials - Alternatives and Limits" (2006)
- 5 L.Xiao-fei et al, "Recent Developments of Modern Rail Steels" (2000)
- 6 H.Yokoyama, S.Yamamoto, T.Sugiyama, "High Strength Bainitic Steel Rails for Heavy Haul Railways with Superior Damage Resistance" (2001)