

# STUDYING A FEEDBACK CONTROL METHOD TO STRENGTHEN FLATNESS CONTROL FOR NON-FINAL STANDS IN TANDEM COLD MILLS\*

Kim, Ki Nam<sup>1</sup>  
Woo, Kyoung Sik<sup>2</sup>  
Hur, Seung Min<sup>3</sup>

## Abstract

Tandem cold mill (TCM) is a process to obtain flatness as well as thickness desired by the customer by rolling hot-rolled coils continuously. The final stand of the TCM plays the most important role of flatness control, which usually uses the real-time measurement at the exit. However, as the material property increases, it is not easy to handle flatness with only the final stand. In order to overcome such a limitation, we propose a feedback control method to strengthen flatness control for non-final stands. The proposed method was tested in an actual production line, and the effect is proved for 45K or less steel grade.

**Keywords:** ASC(Automatic Shape Control); TCM(Tandem Cold Mill); Flatness Control; WRB(Work Roll Bender).

<sup>1</sup> Bachelor's degree, Junior research engineer, New Rolling Processes, Hyundai-steel, dangjin, Chungnam, republic of KOREA.

<sup>2</sup> Master's degree, Junior research engineer, New Rolling Processes, Hyundai-steel, dangjin, Chungnam, republic of KOREA.

<sup>3</sup> Doctor's degree, Senior research engineer, New Rolling Processes, Hyundai-steel, dangjin, Chungnam, republic of KOREA.

## 1 INTRODUCTION

In recent years, automotive steel sheets have been continuously demanded for high strength and thin sheets. In particular, global automobile companies are demanding more strict assurance of the uniformity of the product's flatness. The flatness of the strip is largely influenced by flatness-related actuator (bending, shifting), mechanical characteristics (roll crown, roll taper), material characteristics (plastic/elastic curve), and rolling characteristics (roll force, roll speed, tension). The research on this is being actively carried out.

There was studying of developing profile simulator by modeling the rolling mill using FEM technique. In the study, efficiencies of each of actuators (Work roll bender, Intermediate roll bender, and Intermediate roll shift) are calculated [1]. In addition, the transverse and longitudinal rigidity characteristics are obtained when intermediate roll shifting changes with the simulator [2]. In addition, there have been researches on work roll bending, intermediate roll bending, and intermediate roll shifting to derive profile simulator using mathematical formula [3]. There is also a study on strip profile according to rolling information. In that study, a rolling simulator was modeled through the FEM method. Based on the elastic-plastic deformation theory of the strip and the elastic deformation theory of the roll, the roll profile, the roll force, and finally the strip profile according to the vertical stress of the rolling mill were predicted [4]. In studies based on mechanical properties, there have been studies on optimal roll contour design to control edge drop and crown [5].

Among these, the most convenient factor to control the flatness during rolling is flatness-related actuator in terms of cost and accessibility. However, most of the previous researches have been conducted on the influence of the final stand(STD)'s actuator. But as the material property

increases, it is hard to control flatness by only the final stand.

Therefore, in this paper, after describing conventional flatness control method, we propose a method of using non-final STD's flatness-related actuator. And then we are going to verifying how much the proposed method has the effect on the flatness.

## 2 CONVENTIONAL FLATNESS CONTROL METHOD

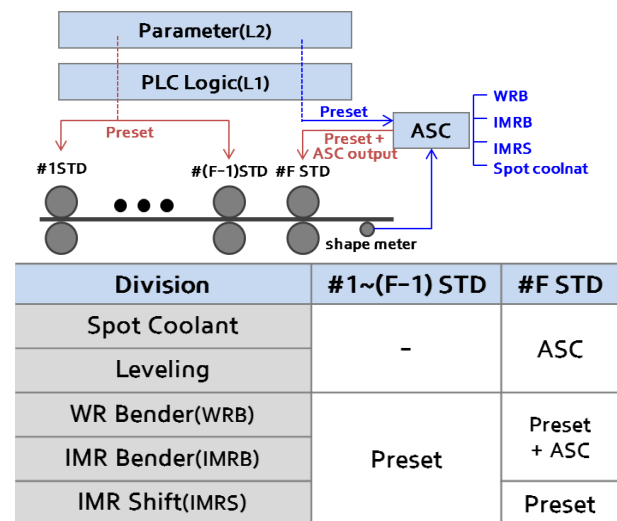


Figure 1. Flatness Control for TCM

In tandem cold mills, the final stand is normally used for flatness control, while the other stands are used for thickness control. Note that in order to prevent undesirable contact area, universal crown control mills (UCM mills) tend to be used in cold rolling mill. In UCM mills, three kinds of control factors such as work roll bender (WRB), intermediate roll bender (IMRB), and intermediate roll shift (IMRS) can be used for flatness control. Besides, leveling and spot coolant system can be adopted additionally.

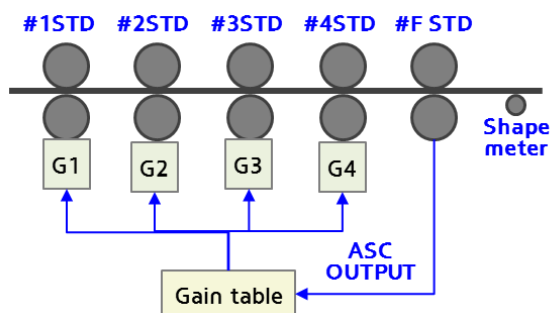
Figure 1 shows the structure of flatness control system of the cold rolling mill, and summarizes how control factors are used at each stand. The flatness control system consists of L2 system(parameter), L1 system (control), and automatic shape control (ASC) system only for the final stand [6]. Since a shapemeter is positioned at the exit, the final stand can use

feedback control, while the other stands use preset method. Note that the preset method means the way to keep the setup value from L2 system unchanged in a coil. Preset values for WRB, IMRB, IMRS, and leveling are determined by tabulated fixed values. On the other hand, in the final stand, ASC output (WRB, IMRB, Leveling, Spot Coolant) is generated by collecting the flatness data in real time and transmitted to the equipment as the final flatness control output in order to regulate flatness deviation.

Theoretically, since the flatness deviation is checked and controlled, the function of removing the flatness variation within a coil can be performed. However, in the production of cold-rolled coils, as hardening proceeds more and more, it could be difficult to eliminate flatness deviation only by the ASC function of the final stand. Hence, in this paper, we propose a method to strengthen flatness control by extending feedback control to non-final stands

### 3 A PROPOSED CONTROL METHOD

As described in Chapter 2, the conventional flatness control system is designed to focus on the final stand. With such a concept, it is difficult to remove the flatness deviation originated from the property deviation of material in the coils. To overcome this limitation, we propose ASC control output feedback (ASC-FB) method.



**Figure 2.** The concept of ASC-FB method

Figure 2 shows the concept of ASC-FB method, which utilizes the ASC output at

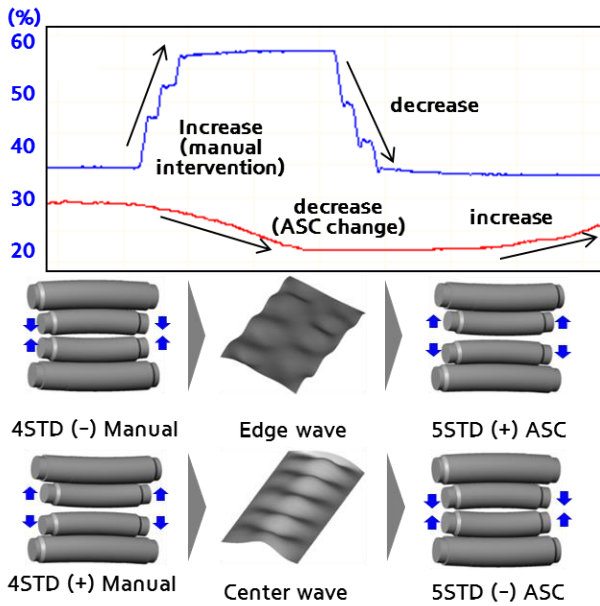
the non-final stands as well as the final stand. The proposed method can reduce the burden of flatness control in the final stand, and share it with the other stand.

ASC-FB method uses only WRB and IMRB outputs. In the case of leveling, it is not fed back because strip can be biased in one side. Non-final stands receive the final stand's ASC output, use their own gains for ASC-FB, and finally develop simple P(proportional) control output. Note that the gains are tabulated according to size or strength. Moreover, in the non-final stands, the control delay increases. Thus, it is very important to set the gains to get the stable performance.

### 4 RESULTS AND DISCUSSION

Before adopting the proposed control method directly, feasibility test is needed. Thus, the test that how much non-final stand's WRB has influence on flatness was performed in an actual production line with 5 STDs of 6 high mill.

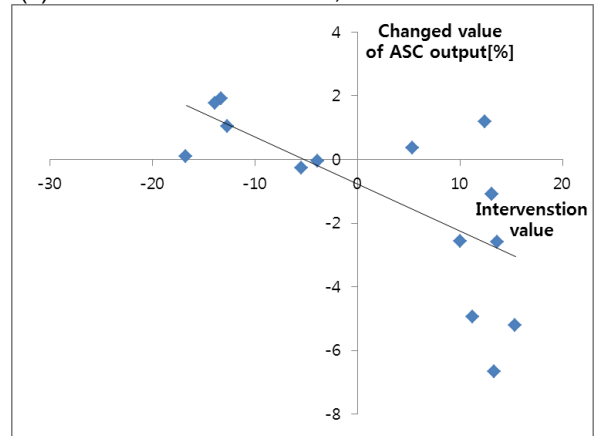
When the operator manually operated WRB of #4STD, we examined the change of #5STD's WRB ASC output accordingly. Figure 3 shows how the test was performed. If the #4STD's WRB is manually operated in the positive direction (Bender gap open), center wave occurs. To control this, automatic control output of the #5STD's WRB is generated in the negative direction. Conversely, when the #4STD WRB is manually operated in the negative direction (Bender gap close), edge wave occurs. To control this, automatic control output of the #5STD's WRB is generated in positive direction. The test was performed with 45K or less steel grades, 0.6~2.0mm of thickness, and 800~1540mm of width.



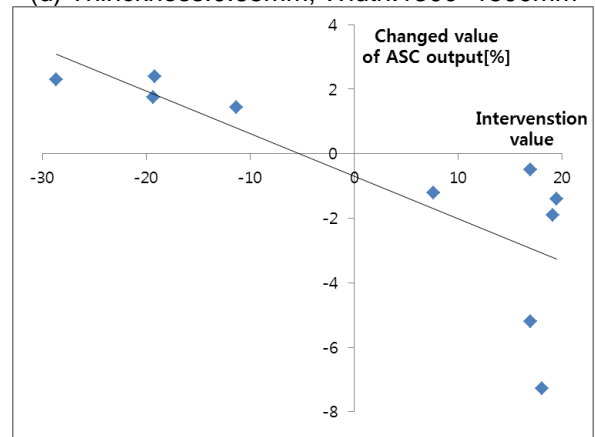
**Figure 3.** Flatness and #5STD's WRB operation when #4STD's WRB is manipulated

The results are shown in Figure 4. The x-axis is the manual manipulated value of #4STD's WRB, and the y-axis is the changed value of ASC output of #5STD's WRB.

(c) Thickness:0.6~0.7mm, Width:800~1200mm

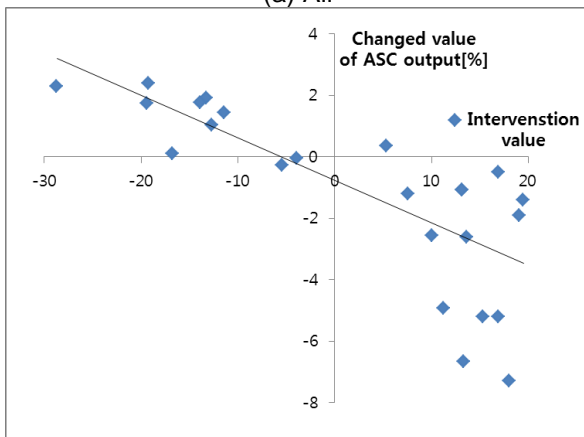


(d) Thickness:0.65mm, Width:1300~1500mm

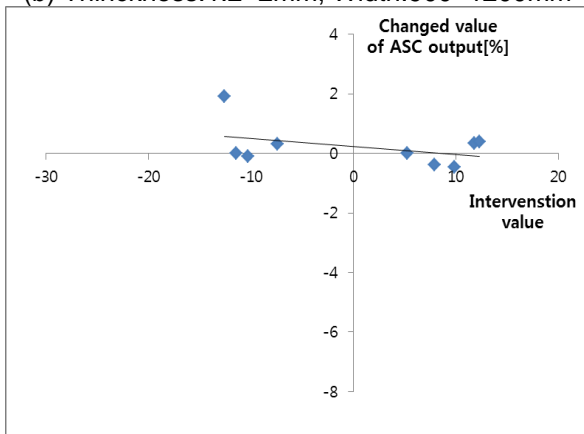


**Figure 4.** Changed value of automatic control output of #5STD's WRB when #4STD WRB is manipulated

(a) All



(b) Thickness:1.2~2mm, Width:900~1200mm



All graphs show roughly lines of negative slope. As mentioned above, the amount of change in flatness due to the amount of operation of #4STD's WRB is compensated by the ASC output of #5STD.

Table 1 shows the regression equation and  $R^2$  value in the graph in Figure 4. In the Table 1, as the strip is thinner and wider, the  $R^2$  value becomes larger, which means that the thinner and the wider the strip is, the greater the influence of #4STD's WRB on the final flatness is. The slope is from -0.133 ~ -0.148, which indicates that the #4STD's WRB has about 6% of influence compared to #5STD WRB in changing the same amount of flatness.

**Table 1.** Results of #4STD WRB manual intervention test(45K or less)

Size(mm)		Regression equation	R <sup>2</sup>
Thickness	Width		
1.2~2	900~1200	$y = -0.027x + 2.3$	0.18
0.6~0.7	800~1200	$y = -0.148x - 7.8$	0.46
0.65	1300~1500	$y = -0.133x - 5.8$	0.62

## 5 CONCLUSION

In this study, we analyzed the influence of proposed a method to strengthen flatness control. Besides, the effect of the proposed method was assessed in advance by studying the manual intervention test for the influence of non-final STD's WRB. The test was performed with 45K or less strips, and it was shown that influence on flatness was relatively large in relatively thinner and wider strips( $R^2= 0.62$ ). Also, the slope was about 0.15, which means that it has about 6% effect compared to Final STD's WRB.

It should be stressed that the ASC-FB function will be effective when applied to thin & wide strips of which grade is 45K or less. Furthermore It is worth examining the application of the ASC-FB function after analyzing the influence of the non-final STD's WRB on the flatness by performing the same test on high strength steels (over 60K). Moreover, the ASC-FB will be adapted in an actual production line. In the actual line test, it will be compared which combination of stands to use the measurement feedback is best. Also, it will be studied how the gains for each stand are distributed.

## REFERENCES

- 1 Qing-Long Wang, Analysis of symmetrical flatness actuator efficiencies for UCM cold rolling mill by 3D elastic-plastic FEM, Steel research, 2018
- 2 Qing-Long Wang, Numerical Analysis of Intermediate Roll Shifting-Induced Rigidity Characteristics of UCM Cold Rolling Mill, Steel research, 2018
- 3 Cui, Xiang Zi, Study prediction of edge strip profile in cold rolling, 2010, Available from:<http://www.ndsl.kr/ndsl/search/detail/article/articleSearchResultDetail.do?cn=D IKO0012042983>
- 4 Hyojin Park, 3-D Coupled Analysis of Deformation of the Stripand Rolls in Flat Rolling by FEM, ,Steel research, 2017
- 5 Cao Jian-guo Integrated design of roll contours for strip edge drop and crown control in tandem cold rolling mills, Journal of Materials Processing Tech., 2018
- 6 Y.Hashimoto, No.2 CRM Dangjin Works : PL-TCM Operation Procedure (STEP-2 ASC), HITACHI Ltd., 2011