

VAI PICKLING LINE FOR VALUE-ADDED ULTRA THIN HOT STRIP¹

*Daniel Sylvain²
José Antonio Conde³
Philippe Podda⁴*

Abstract

The production of thinner strip by new hot rolling plants leads to build specialised pickle lines able to value-added ultra Thin hot strip that can be sold directly on the cold band market. The line supplied by VAI for A.C.B. of Arcelor Group has been specially designed for the purpose. The Clecim™ Mash Lap welder is used to join the strip, a wet scale breaker improves the flatness of the strip, the turbulent VAI pickling tanks give a high operation flexibility, and the skin-pass mill installed at the end of the process section provides the necessary surface conditioning. This line gives considerable added value to the plant production.

Key words: Mash Lap welder; Scale breaker; Turbulent pickling; Side jets; Turret type side trimmer; 4 High temper mill.

¹ *Paper presented at 42th Rolling Processes, Rolled and Coated Products Seminar of ABM; Santos, SP, October 25 to 26, 2005.*

² *Process Consultant - VAI CLECIM, St Chamond, France*

³ *Proposals Manager - VAI COSIM, Bilbao, Spain*

⁴ *Proposals Manager – VAI CLECIM, St Chamond, France*

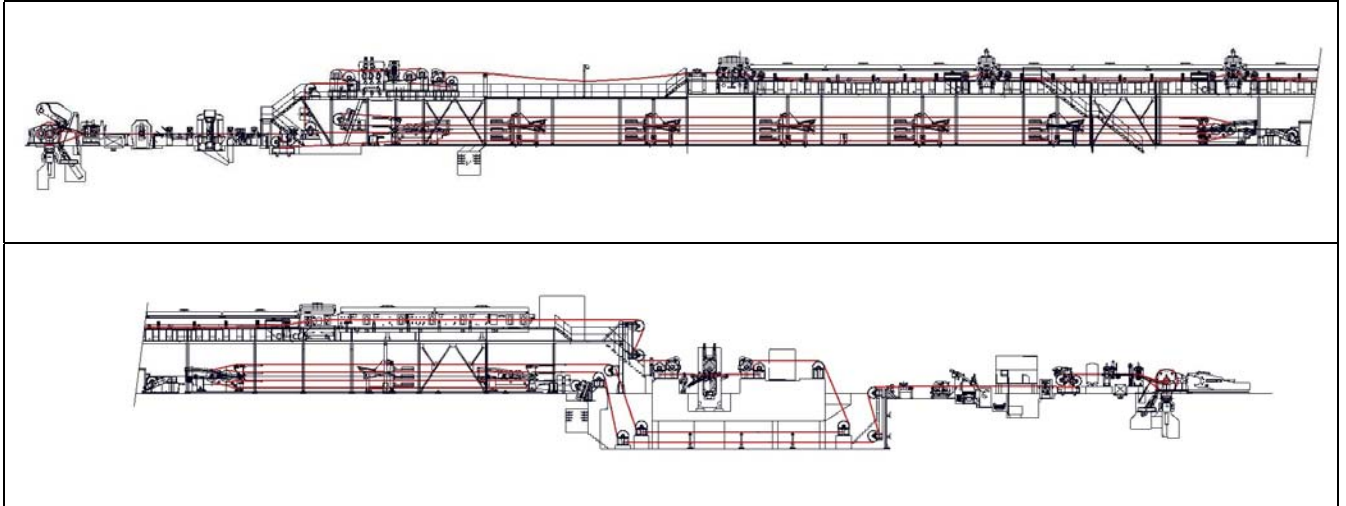

Figure 1. Layout of ACB Thin Gauge Pickling Line

1 INTRODUCTION

In 2000 ACB (Aceria Compacta de Bizkaia, Bilbao, Company of Arcelor Group) decided to double the capacity of the thin slab caster and of the hot mill and to increase the yearly production from 1,000,000 to 1,800,000 t/y.

To cover a larger market for the additional tonnage a new pickle line had to be installed.

As the upstream plant is able to roll ultra thin hot strip, the objective is that the pickle line should be able to process thin gauges and to supply the market with strip similar to cold strip.

VAI has been awarded the complete project of this new line.

2 GENERAL DESCRIPTION

The design plant data are

- Thickness 0.8-3 mm (4mm exceptional)
- Width 790-1560 mm
- Line speeds
 - Entry 240 mpm
 - Process 180 mpm
 - Exit 240 mpm
- Yearly production 450,000 t/y

Even if the production level is medium, the thin gauge (average thickness 1.2 mm and strip length to produce about 45000 km/year) as well as the high surface quality demands have led to select a **continuous** pickling line.

Line entry

The entry of the line includes

- A preparation section
- A single uncoiler entry
- A Mash Lap welder.



Figure 2. Mash Lap Welder.

The Mash Lap welder has been selected because it is the best compromise between the following requirements

- Weld able to pass through the scale breaker without any change in the process
- Weld able to be skin-passed
- Weld carried out in a short time
- Lowest investment cost.

The use of a Mash Lap welder on a non-pickled hot strip is possible thanks to the brushing unit removing the scale from the strip to be welded.

The four-strand entry accumulator permits the entry section to operate without stopping the process section.

Scale breaker



Figure 3. Scale Breaker

At entry of the process section the scale breaker ensuring up to 3% elongation on the strip facilitates the pickling operation and last but not least gives the strip the perfect flatness (6 IU) requested by the market.

This equipment is a wet type scale breaker allowing cleaner operation and the work roll diameter has been adapted to the thickness range.

Process section

The process section uses catenary turbulent tanks. This arrangement has been chosen due to the high surface quality of the finished product to be processed and also for its high flexibility.

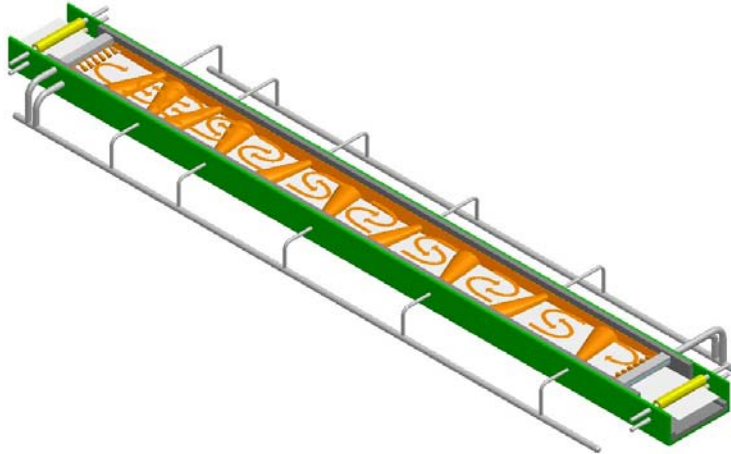

Figure 4. Principle of turbulent tank.

The catenary design guarantees that the strip will never touch any fixed part, therefore it will not get any scratch.

The pickling tank, made of polypropylene, is designed to follow the catenary of the strip in order to minimize the acid volume in the process tank.

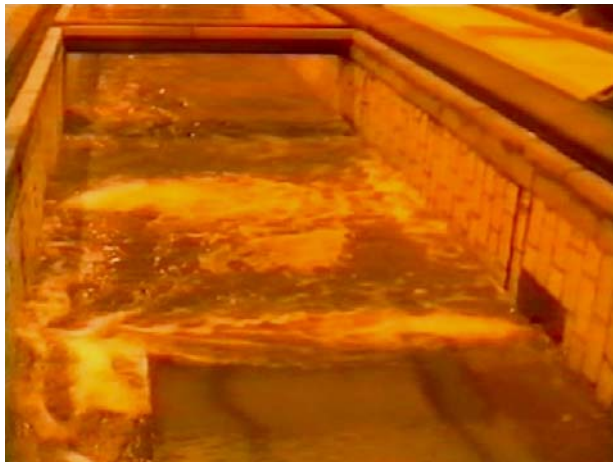

Figure 5. Side jets in Pickling tank.

Deflector rolls have been installed above the strip in order to prevent the strip being raised out of the acid bath in case of tension control failure.

Acid is injected into the tank by entry spray headers as well as by 8 side jets *located both sides of the tanks* and ensuring high turbulence throughout the process.

The side jets are located in front of the strip during the process (i.e. at a height following the catenary of the strip along the tank) in order to get the most efficient action of the acid stream.

In order to insure the injection into the tank, the acid heated through the heat exchangers is pumped from the recirculation tanks.



Figure 6. Side Jets

One significant feature is that turbulence is independent of the strip speed allowing the process section to run at lower speed keeping the full efficiency of turbulent pickling.

This gives the line a high operational flexibility.

Wringer rolls minimising the acid drag-out separate the pickling tanks. Efficient separation between the pickling tanks minimises the iron content in the downstream tanks, increasing the pickling efficiency.



Figure 7. Rinsing section

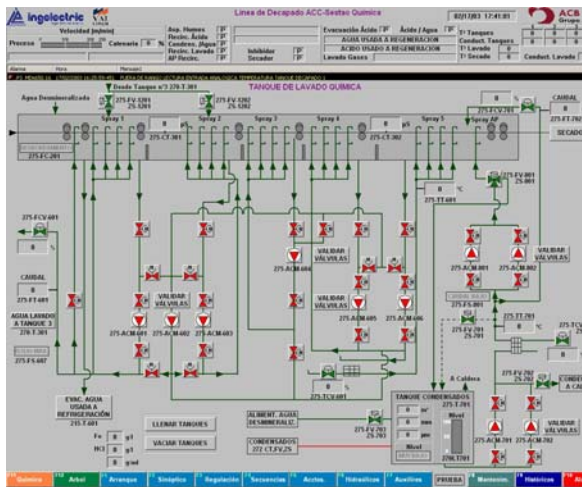

Figure 8. Rinsing section scheme

The 5-cell rinsing section allows the strip to be rinsed with a minimum demineralised water consumption. The final high-pressure spray header gives the strip a perfect cleanliness.

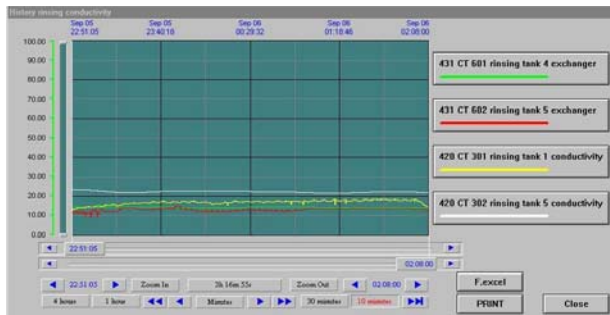
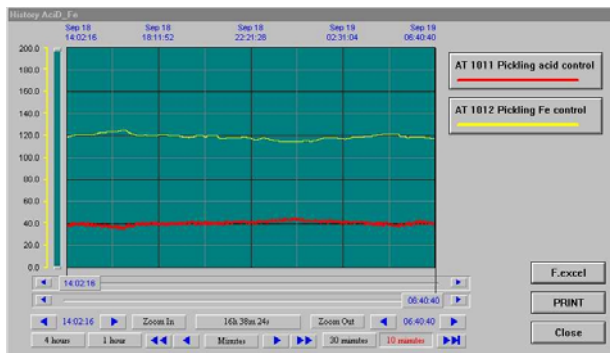

Figure 9. Typical parameter display

All the process section main parameters (acid-iron content, rinse water conductivity etc...) are automatically measured and controlled through a mathematical model, computer and PLC.

With regard to the environmental aspect this line is also exemplary. All rejects are treated directly in the plant.

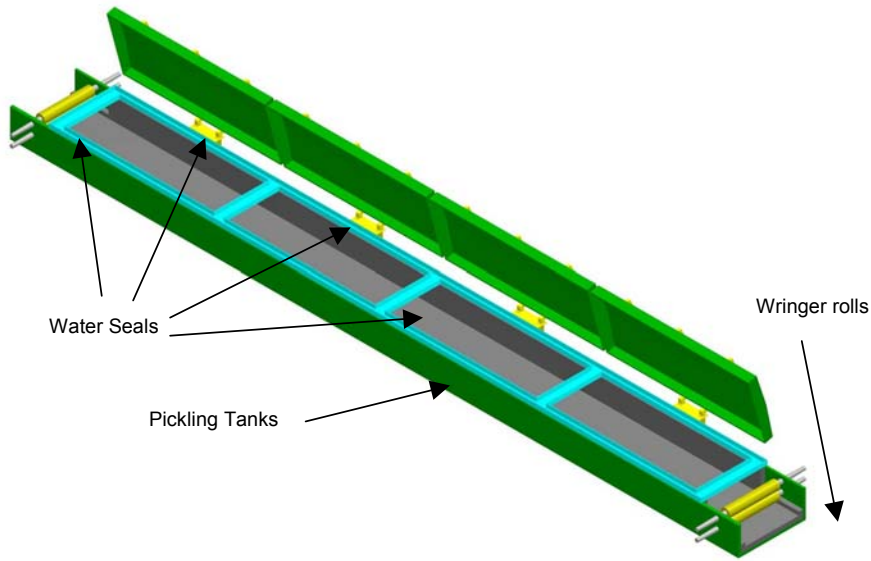

Figure 10. Pickling Tanks with full water seals around covers

Due to the complete water seal design (i.e. even across the tanks), the tank covers are perfectly tight allowing the fume exhaust flow in the pickling tanks to be drastically reduced. Therefore the fume scrubber can keep the acid level in the fume far below the European requirement minimising the water consumption.

Temper mill



Figure 11. 4-high Temper Mill

Downstream of the process section a four high temper mill is installed in order to achieve the requested surface conditioning. The roll force is 800 t and bending force ± 45 t.

Side trimming

After passing through the exit accumulator the strip can be trimmed in the turret type side trimmer.



Figure 12. Turret type side trimmer

This machine allows knife change during the line run; width and knife gaps are automatically adjusted by servo-motors.

In the scrap chopper, installed downstream of the side trimmer, the head position as well as the knife gap is also adjusted automatically.

After passing through an electrostatic oiler the strip is coiled and evacuated.

Packaging of the coils is done in the same plant

3 CONCLUSION

With this VAI plant, adapted to ultra thin gauge, A.C.B. Arcelor Group is able to produce directly from hot strip a product competing with a large range of cold rolled products.

This new line gives considerable added value to the overall steel plant production.

LINHA DE DECAPAGEM VAI PARA A PRODUÇÃO DE TIRAS A QUENTE ULTRA-FINAS DE ALTO VALOR AGREGADO ¹

*Daniel Sylvain²
José Antonio Conde³
Philippe Podda⁴*

Resumo

A produção de tiras mais finas pelas novas laminações a quente tem levado à construção de linhas de decapagem especializadas, capazes de produzir tiras a quente ultra-finas de alto valor agregado, as quais podem ser vendidas diretamente no mercado de tiras laminadas a frio. A linha fornecida pela VAI para a A.C.B. do Grupo Arcelor foi especialmente projetada para esta finalidade. A máquina de soldar Clecim™ Mash Lap é usada para unir a tira, a máquina de quebrar carepa a úmido melhora a planura da tira, os tanques VAI de decapagem turbulenta oferecem uma alta flexibilidade operacional, enquanto o laminador de acabamento e encruamento superficial instalado no final da seção de processamento proporciona o necessário condicionamento superficial. Esta linha agrega um considerável valor à produção da usina.

Palavras-chave: Máquina de soldar Mash Lap; Máquina de quebrar carepa; Decapagem turbulenta; Jatos laterais; Aparadeira lateral tipo torre; Laminador quádruplo de encruamento.

¹ *Contribuição Técnica ao 42º Seminário de Laminação Processos e Produtos Laminados e Revestidos; 25 a 28 de Outubro de 2005, Santos, SP, Brasil.*

² *Consultor de Processo - VAI CLECIM, St Chamond, França*

³ *Gerente de Propostas - VAI COSIM, Bilbao, Espanha*

⁴ *Gerente de Propostas – VAI CLECIM, St Chamond, França*