

ADVANCED TECHNOLOGY IN SKIN PASS ROLLING ¹

Rüdiger Holz²
Karl Hoen³
Karsten Weiss⁴

Abstract

Requirements in terms of mechanical properties and surface quality of cold strips are becoming stricter all the time. Therefore the whole process chain needs to be optimized and skin pass rolling, as last step in the process chain, becomes more and more important. The subject paper gives an overview of the latest technology in skin pass rolling. The use of inert gas and its combination with an appropriate lubrication concept is presented. Referring to operational results the advantages are discussed. The concept of the extended bending system for improving skin passing of very soft material is explained. It increases the spectrum of steel grades, which can be skin passed on one mill. A further component considered for the optimization of skin pass rolling is automation. Here, an innovative elongation control concept is presented, which by way of a model approach in unsteady operating conditions corrects the tension and rolling forces in order to minimize variations in strip elongation. Finally, newly developed online measurement devices are introduced together with their integration in an overall automation concept.

Key words: Low volume lubrication; Liquid nitrogen application; T-roll[®]; Elongation control; Extended bending system; Residual oil contents measurement.

TECNOLOGIA AVANÇADA EM LAMINAÇÃO DE ENCRUAMENTO

Resumo

Os requisitos em termos de propriedades mecânicas e qualidade da superfície dos laminados a frio são cada vez mais rigorosos. Por isso, toda a cadeia do processo precisa ser otimizada e a laminação de encruamento, enquanto fase final da cadeia do processo, vai assumindo uma importância cada vez maior. Nessa contribuição técnica é apresentada uma visão geral dos mais recentes avanços tecnológicos no domínio da laminação de encruamento. É apresentado o uso de gás inerte combinado com um conceito adequado de lubrificação. São igualmente discutidas as vantagens com base nos resultados operacionais. É aqui explicado o conceito de um sistema alargado de dobramento para melhorar o encruamento de material extremamente macio. A vantagem reside no aumento do espectro de qualidades de aço que podem ser encruadas em um laminador. Um outro componente considerado relevante para a otimização da laminação de encruamento é a automação. Neste contexto, apresentamos um inovador conceito de controle do alongamento, o qual, em condições operativas instáveis, corrige, através de um modelo, a tensão e as forças de laminação, de maneira a minimizar as variações em termos de alongamento da tira. A finalizar, são apresentados os mais recentes desenvolvimentos na área dos dispositivos de medição online, a par da sua integração em um conceito global de automação.

Palavras-chave: Lubrificação de baixo volume; Aplicação de nitrogênio líquido; T-roll[®]; Controle do alongamento; Sistema alargado de dobramento; Medição do teor de óleo residual

¹ *Contribuição técnica ao 45° Seminário de Laminação – Processos e Produtos Laminados e Revestidos, 21 a 24 de outubro de 2008, Ipojuca - Porto de Galinhas - PE*

² *Dipl.-Ing., Executive Vice President Cold Rolling Mills Division, SMS Demag, Germany*

³ *Dipl.-Ing., General Manager Plant Technology, SMS Demag AG, Germany*

⁴ *Dipl.-Ing., Manager Technical Sales Skin Pass Mills, SMS Demag AG, Germany*

INTRODUCTION

Against the background of a global market, rolling-mill owners are under constant pressure to cut their production cost and to open up new market segments with the help of innovative products. At the same time, requirements in terms of strip quality, such as thickness and flatness tolerances, surface structure and mechanical properties, are becoming stricter and stricter.

SMS Demag as a provider of complete solutions for rolling mill equipment is faced with the challenge of taking appropriate measures to help achieve these targets. Therefore, conducting continuous and wide-ranging development activities is indispensable for SMS Demag. Long-standing solutions need to be questioned and new technologies examined for their usability and benefits in rolling mills.

With regard to skin pass rolling, our main areas of development are:

- improving flatness and surface quality
- increasing flexibility to handle high strength material like DP1000 as well as very soft material like IF-grades
- improving the automation by process models and control systems based on innovative online measurement devices

APPLICATION OF LOW VOLUME LUBRICATION AND LIQUID NITROGEN

As a new lubrication and cleaning concept, SMS Demag developed together with AIRPRODUCTS and C.D.Wälzholz a combination of low volume lubrication and the utilization of liquid nitrogen. In skin pass rolling, this concept decisively improves the strip surfaces and at the same time curbs the operating costs.

The low volume lubrication applies the lubricant in the skin-pass stand entry. This reduces the friction in the roll gap and therefore the rolling force and improves flatness while using a minimum quantity of lubricant at the same time. The liquid nitrogen in the exit covers both the strip surface and the roll surface.



Figura 1: Combination of low volume lubrication and liquid nitrogen for skin pass rolling

This method has the following advantages:

- clean and dry strip surfaces and thus clearly lower susceptibility to rust,
- clearly reduced efforts in the downstream cleaning steps for cleaning the strip surface and
- prolonged work roll service lives.

Installation

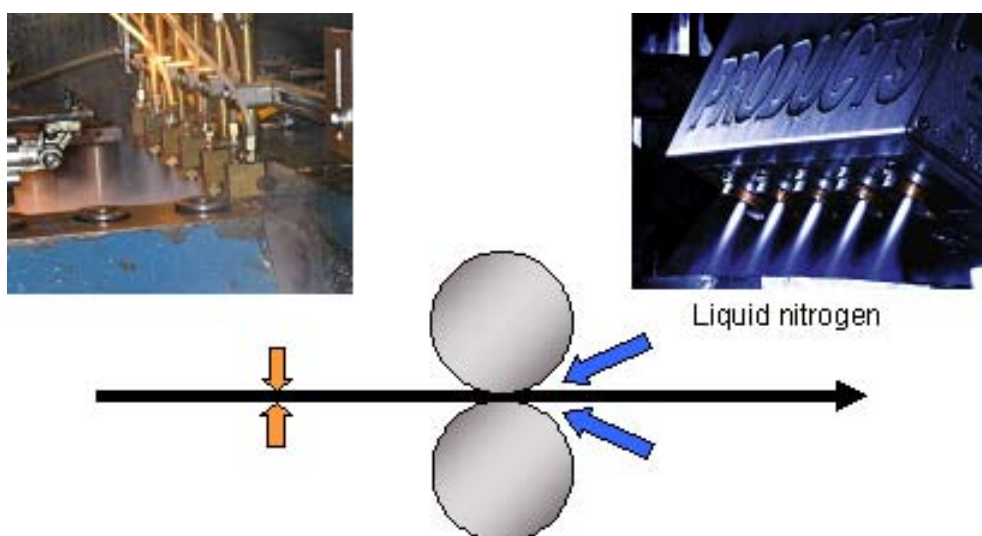
The major components of the low volume lubrication are

- the nozzle beam
- the volume controller and
- the tank, pump and control unit

Two nozzle beams are installed one for the top and one for the bottom strip surface.

Due to the small amount of lubricant applied, its equal distribution can only be ensured by atomizing the lubricant with the nozzle using compressed air.

The volume controller ensures a constant flow rate during operation. Three different configurations are available: one controller for each nozzle, one controller for a group of nozzles or one controller for one nozzle beam.



Figure 2: Tank, pump and control unit of the low quantity lubrication

The picture of the tank, pump and control unit (Figure 2) underlines the compactness of the system which can be easily installed in existing mills. All these components were developed together with our partner REBS

The typical installation of nitrogen application consists of the vaporizer and nitrogen tank which are installed outside of the mill hall. Via a vacuum jacketed line the tank is connected to the nozzle system and the supply is controlled via valves. Also this equipment can be installed in existing mills in a short shutdown.

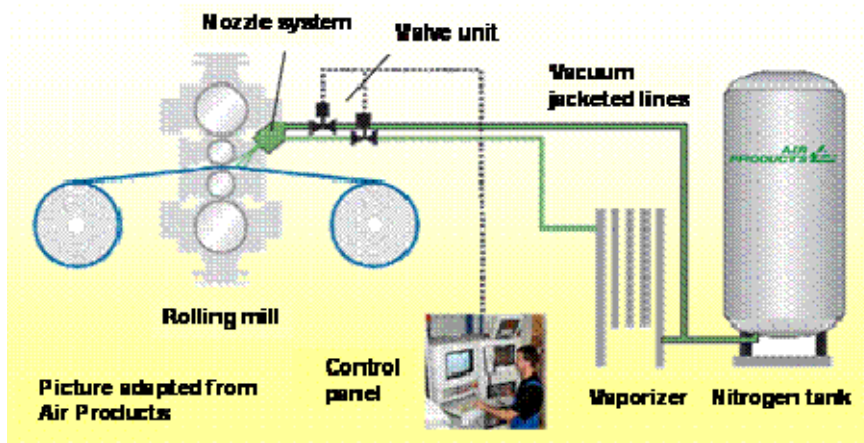

Figure 3: Typical installation of the nitrogen application

Operational results

Liquid nitrogen

For assessment of the strip surface quality using liquid nitrogen, the same material was skin-passed under different operating conditions. In the pass with emulsion, clear impressions of the lubricant were found. They make the surfaces appear less bright. The roll abrasion in dry skin pass rolling has a similar effect on the surface quality. Compared with that, the surfaces are clearly more uniform and thus brighter when using liquid nitrogen.

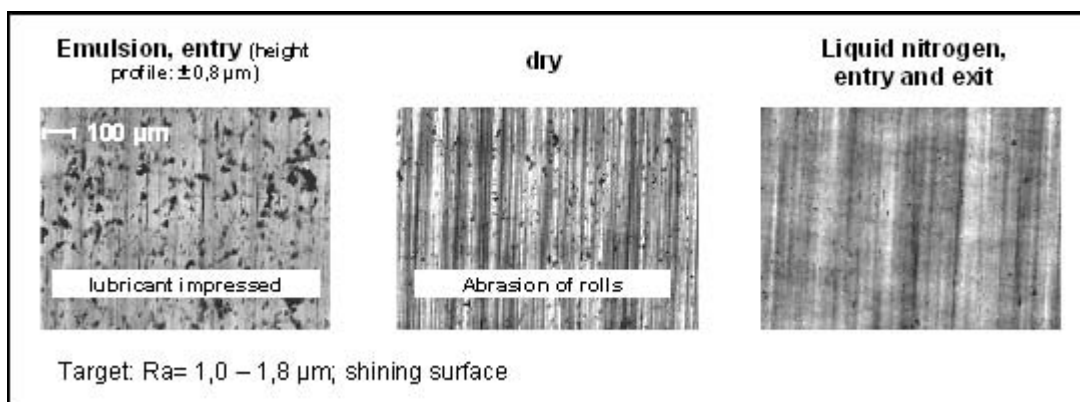

Figure 4: Valuation of surface quality

Moreover, operating experience has shown that the use of nitrogen more than doubled the work roll service lives. This and the lower refinishing effort on the strips enabled our cooperation partner C. D. Wälzholz to cut the process costs of skin pass rolling by approx. 20%.

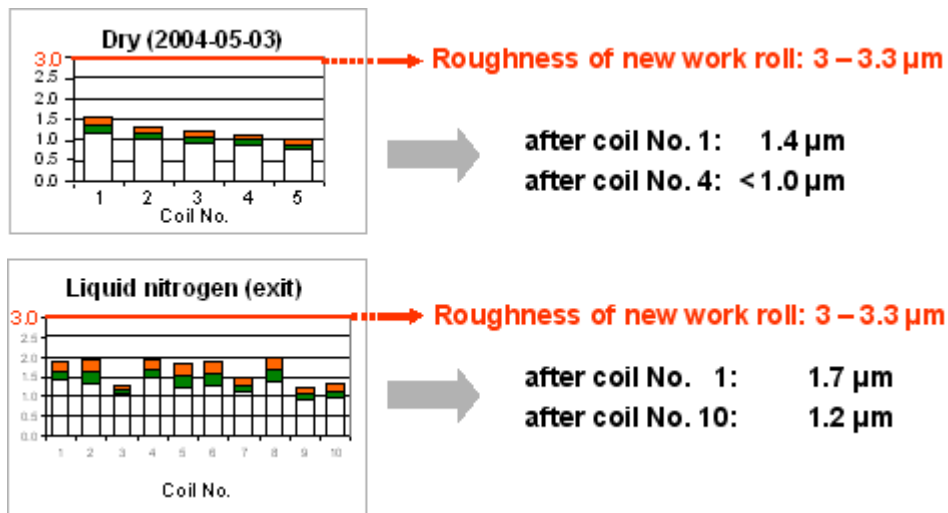

Figure 5: Investigation of work roll service lives

This results out of a cleaning effect of liquid nitrogen which can be explained by a thermal shock. In this context the thermal shock describes the sudden cool down of the roll surface by liquid nitrogen. Due to the different thermal expansions of the roll surface and accumulations of abrasive material and dirt glued together by residual oil as well as the difference in temperature conductivity, the accumulations in the roughness valleys get brittle and flake off. This cleans the roll and in a similar way the strip surface.

Low volume lubrication

Considering the fundamentals of lubrication according Stribeck (Fig.6), cold rolling takes place in area of boundary lubrication. This means roll and strip comes in occasional contact.

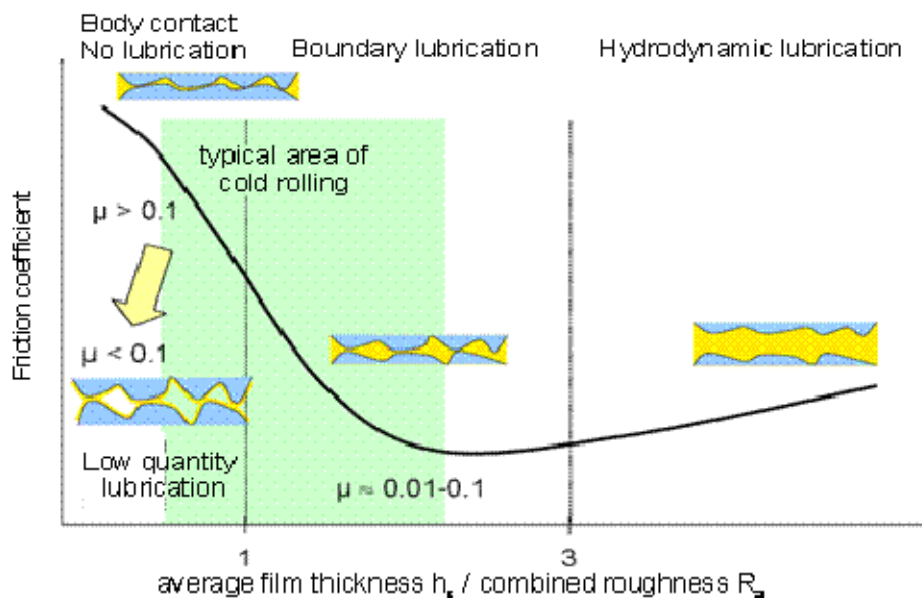

Figure 6: Investigation of work roll service lives

Having a surplus lubrication with higher speed more lubricant is drawn into the roll gap. Roll and strip are better separated by lubricant pockets. This causes imprints of the lubricant on the surface of the strip.

With the low volume lubrication, which applies only a film, which is thinner than combined roughness of the strip surface and roll, these imprints will be avoided.

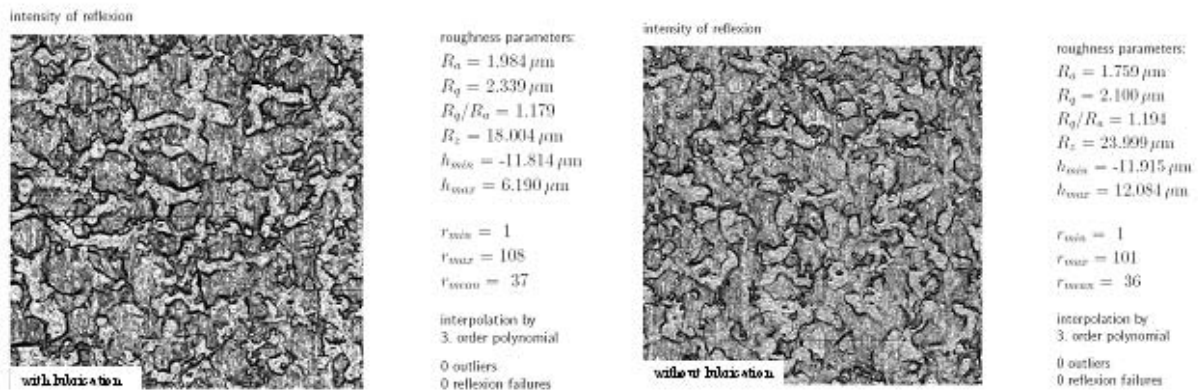

Figure 7: Strip surface quality without and with low volume lubrication

Figure 7 shows the assessment of the strip surface quality rolled without and with low volume lubrication. In both cases the same material was rolled. The typical imprints of the lubricant can not be observed. The strip surface quality is fully comparable.

In addition the benefit of the low quantity lubrication is that the rolling force is reduced. Already a very small amount of oil causes a remarkable decrease in rolling force. With varying the amount of oil in a considerable range the rolling force can be adjusted. This opens up new options in controlling skin pass rolling.

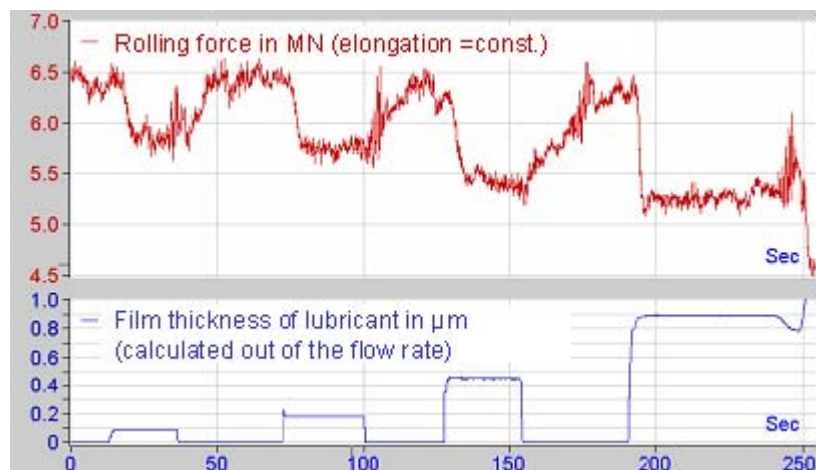

Figure 8: Rolling force reduction depending on the amount of oil applied with the low volume lubrication

Recent reference

C.D. Wälzholz applies the liquid nitrogen now for more than 7 years. In 2000 C.D. Wälzholz started to look for measures to improve and equalize the surface quality, to reduce the efforts in down stream cleaning steps and of cause to reduce the operation cost. Together with AirProducts they made first test with liquid nitrogen. Since 2005 C.D. Wälzholz used the liquid nitrogen for 100 % of skin pass production.

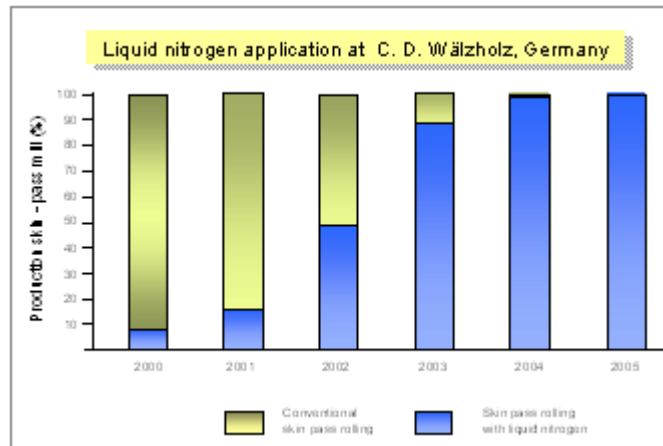

Figure 9: Application of liquid nitrogen at CD Wälzholz

The combination of low volume lubrication and liquid nitrogen application is installed in the new inline skin pass mill at the continuous annealing line of ThyssenKrupp Steel in Dortmund.

On this line, ThyssenKrupp Steel produces a large spectrum of different steel grades from soft IF steels up to high strength TRIP grades.

The skin pass stand is equipped with deflector and anti crimping roll in the entry and exit side. The oil is applied before the deflector roll at the entry side. The liquid nitrogen is applied at the exit side covering only the roll surface which does not reduce the benefits of the system.

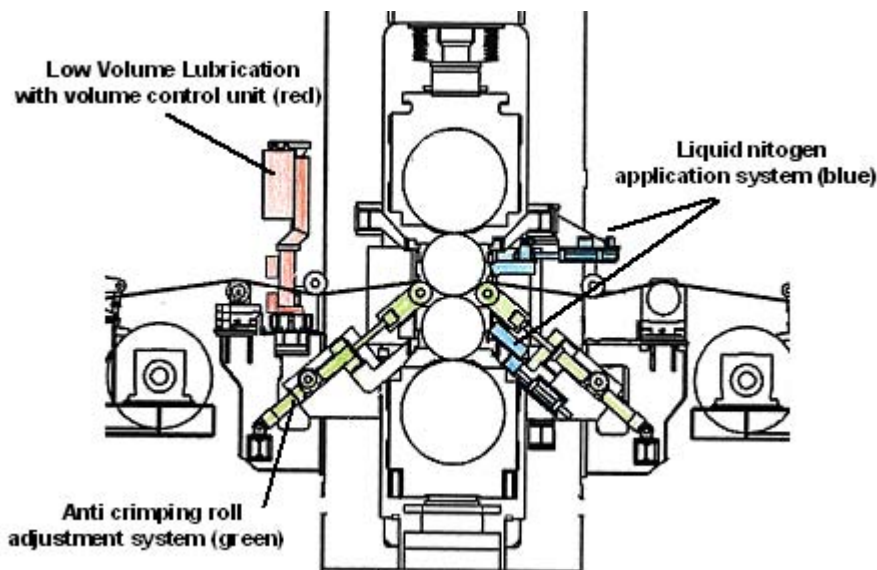

Figure 10: Arrangement of low volume lubrication and the liquid nitrogen application at the inline skin pass mill of the continuous annealing line of ThyssenKrupp Steel in Dortmund, Germany

EXTENDED BENDING SYSTEM

Due to the enlarged product mix, the skin pass mill has to meet different requirements. On the one hand, for ultra-soft material, like IF steels with very low strip elongation of 0.5 % at very low roll forces must be rolled. On the other hand, high-strength strip requires high elongation corresponding with high roll forces. The mill stand has to be designed to suit the maximum required roll force.

Due to this, however, adjusting low roll forces becomes more difficult. For ultra soft material measures like increasing the work roll diameter, reducing tensions and the amount of emulsion used, will not be enough to keep the roll force controllable. Therefore, SMS Demag has developed the Extended Bending System. For roll forces below 700 kN, the top backup roll is withdrawn from and the roll force is only applied through the roll bending system.

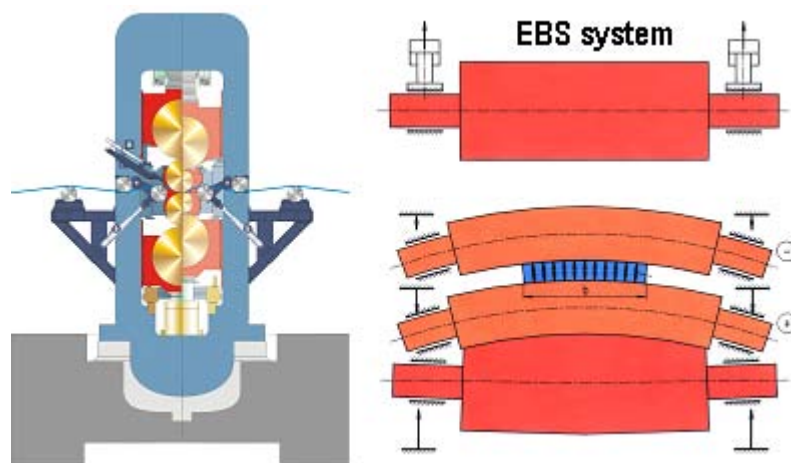

Figure 11: Extended Bending System for 4-high skin pass mill

The latest reference for the Extended Bending System is the CVC plus[®] 6-high inline skin-pass mill of the continuous annealing line for Baosteel.

T-Roll[®]

In order to optimise the cold rolling process in general and skin pass rolling in particular, it is indispensable to understand the physical processes taking place during rolling in a better way. Therefore, SMS Demag has developed T-Roll[®], a technological offline model with a special focus on the tribological processes taking place in the roll gap. Besides dimensioning of cold rolling mills and analysing rolling processes on the site, modules of T-Roll[®] become part of the online process models or the technological control system. The feed forward module of the elongation controller is an example of this. It allows to have more dynamic elongation controllers and therefore to keep elongation and flatness within close tolerances, especially during acceleration and deceleration.

Basically the elongation is adjusted by the control variables rolling force and entry as well as exit strip tension. The strip tensions can only be used if the plant is equipped with bridle roll units in the entry and exit for decoupling the reel tensions from the elongation tensions.

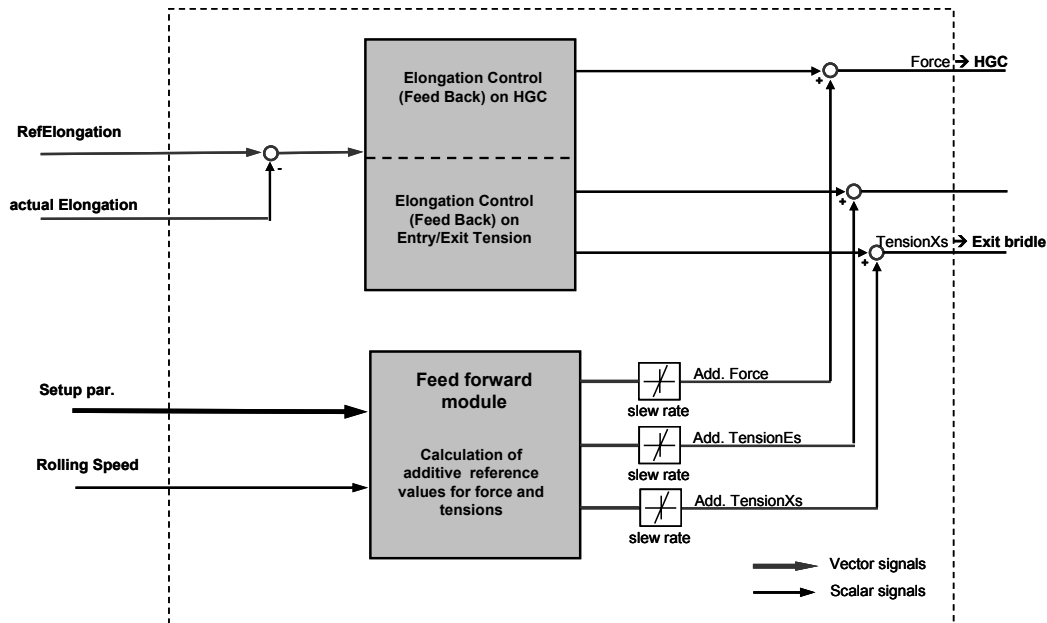

Figure 12: Structure of the elongation controller

Besides the feed forward module the structure of the controller consists therefore of a tension control component as well as an adaptive force control component for feed back control. The feed forward module calculated, based on implemented model, the actual set up as well as the actual speed, the force and tension values, which are added to the output of the feed back controller. Due to this, the elongation control achieves faster the elongation desired in transient situations and so it reduces the length out off tolerance.

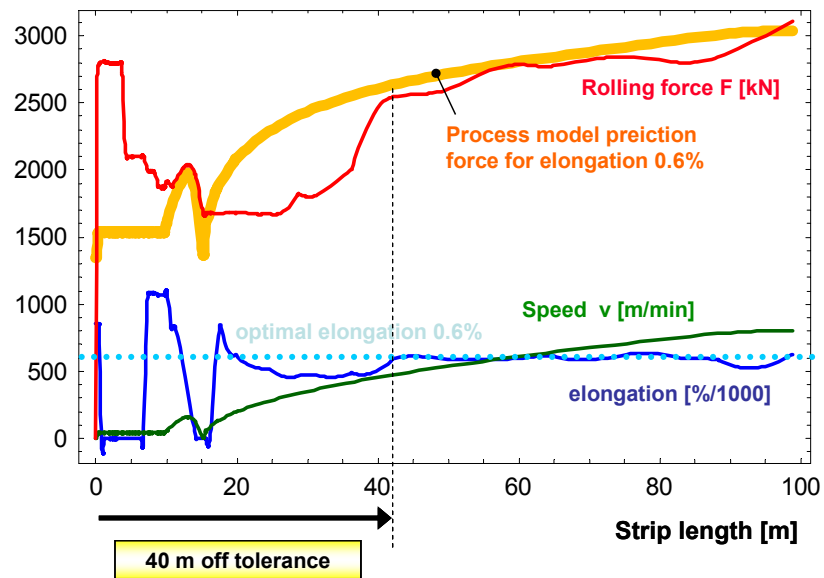

Figure 13: Comparison of the controller output without the feed forward module and the output of the feed forward prediction

The difference of the adjusted force by the feed back control and the predicted force by the feed forward module is shown in Figure 13. It is obvious that the feed forward controller would raise the force faster.

In case both controllers are active this reduces the variation of the elongation even under test condition as demonstrated in Figure 14.

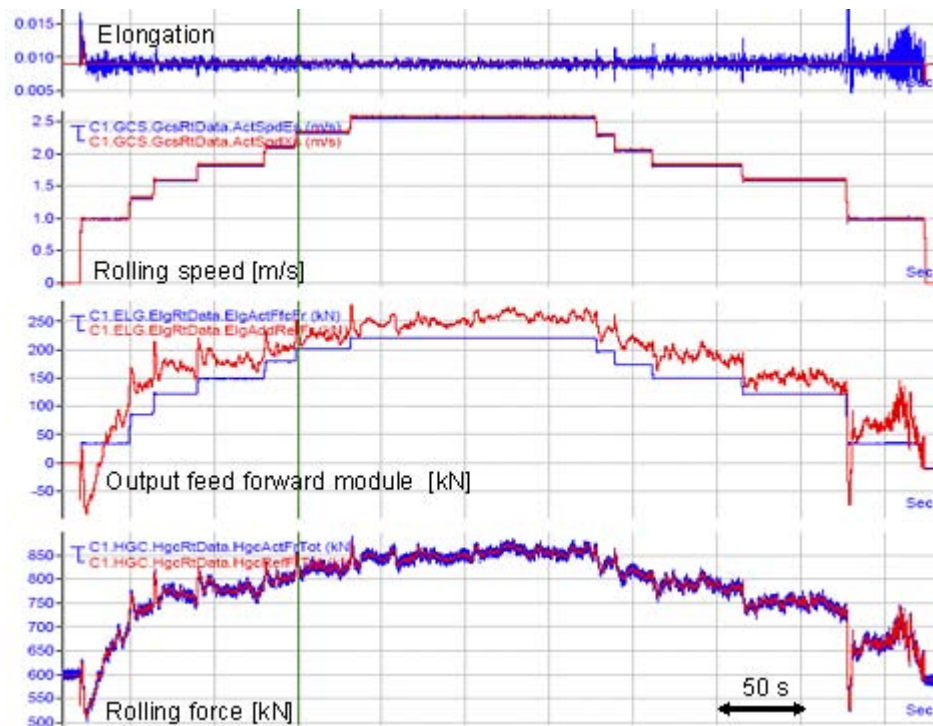

Figure 14: Operational result of the elongation controller with feed forward module

ONLINE MEASUREMENT SYSTEMS AND PROCESS AUTOMATION

Today, efficient production on a high quality level requires complete documentation of the main quality parameters. This is the only way to demonstrate quality towards the customer and to track down the causes for quality problems in the process line efficiently and to improve process control.

Our patented roughness control system allows to control the strip roughness to a constant value along the entire length and to change rolls only, when it is really necessary.

With the low volume lubrication the friction coefficient can be adjusted in the complete range from dry to wet skin pass rolling. This opens up a wide operation window to adjust the roll force. Besides the elongation also the strip roughness can be controlled to a constant value considering the degree of wear of the work roll.

For roughness measurement, the SORM 3 plus measuring system of our cooperation partner EMG is used.

Together with our partner SYSTECTUM, SMS Demag has developed an online measurement device to detect the residual oil contents. The system works on the laser induced fluorescent principle.

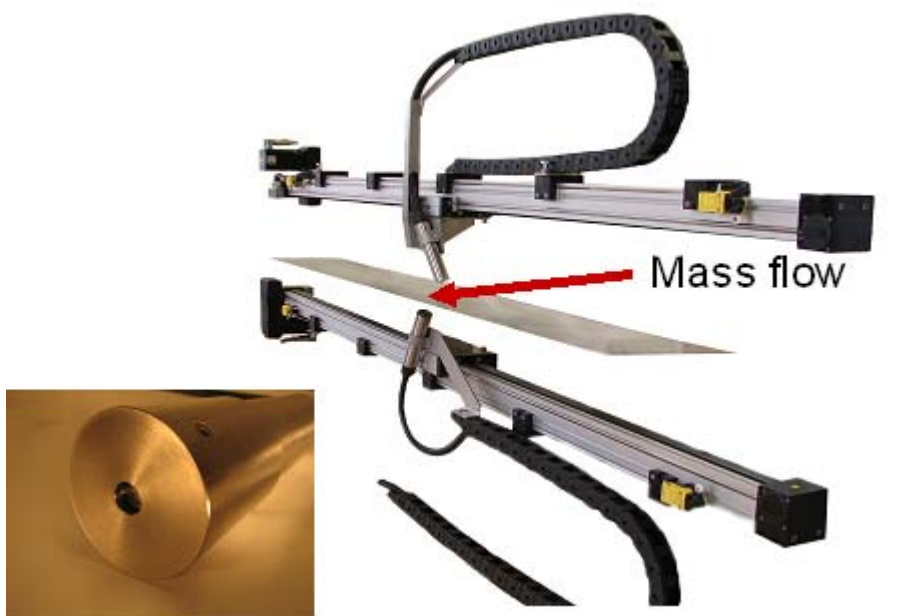

Figure 15: Online residual oil contents measurement

For flatness measurement, SMS Demag offers a shape meter roll based on the BFI principle. The close surface of the roll avoids marking of the strip and can be specifically coated for every application. The roll allows simple installation of the sensors, which can be performed at side.

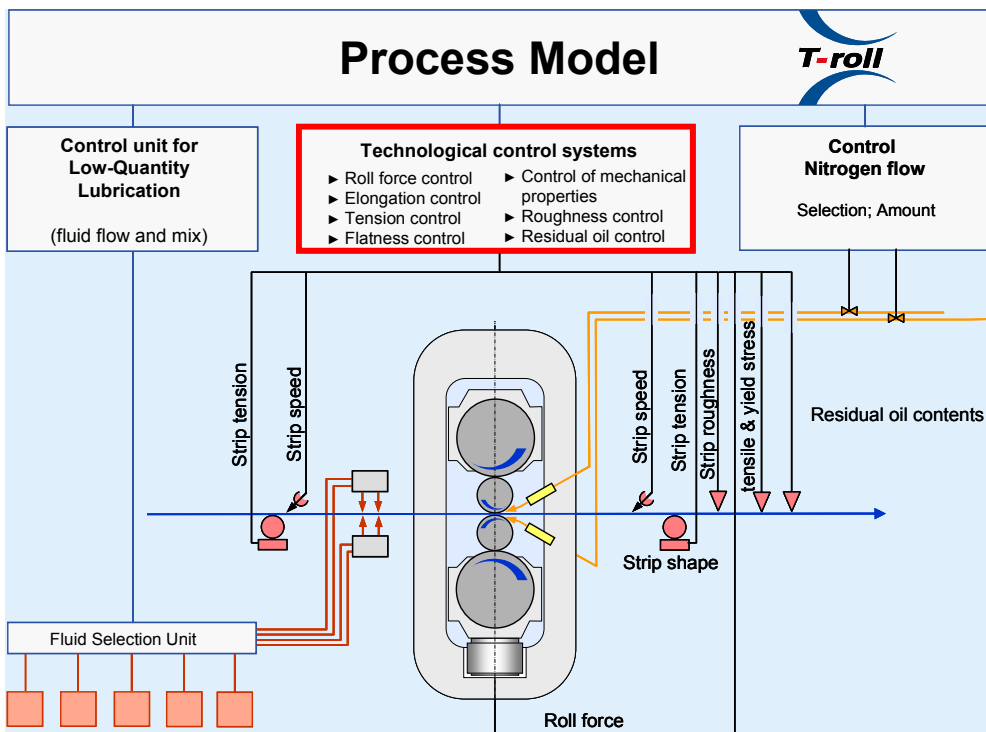

Figure 16: Functional diagram of an advanced skin pass mill automation system

The overall functionality of the advanced automation system for a skin pass mill is shown in Figure 16.

CONCLUSION

Considering the higher requirements in terms of mechanical properties and surface quality of cold rolled strips, skin pass rolling, as last step in the process chain gets more and more important. The presented innovative technologies from SMS Demag help to reduce operation cost, increase plat flexibility and at the same time improve the strip quality.

REFERENCES

- 1 G. Plicht, H. Schillak, H. Höfinghoff, T. Demski, „Cold rolling of metal strip using technical gases“, Proc 4th European Rolling Conference, Paris, June 2006.
- 2 H.-P. Richter, H. Pawelski, W. Denker, R. Holz, K. Hoen, „Innovations in skin pass mills“, Proc. 4th European Rolling Conference, Paris, June 2006.
- 3 H. Pawelski, H.-P. Richter, “Application of low volume lubrication and liquid nitrogen in the final stand of a tandem cold mill”, AISTech 2008 Iron & Steel Technology Conference and Exposition, Pittsburgh, May 2008