

# INDUTEC<sup>®</sup> EAF DUST RECOVERY SYSTEM FOR A ZERO-WASTE STEEL MELTSHOP<sup>1</sup>

**EAF Dust recovery technologies proven in the past are economically feasible today, due to a higher market price of zinc and a greater attention to environmental sustainability**

*Dario Zimolo<sup>2</sup>  
Luciano Tomadin<sup>3</sup>*

## **Abstract**

The quantity of fume abatement dust generated annually with a 1 Mtpy steel meltshop can be up to 25,000 tonnes. EAF dust is classified as a hazardous waste by environmental control agencies. Danieli is committed to build “Zero-Waste” meltshops, thus the recovery of EAF Dust is a priority of the company’s environmental department. The most common process is the Waelz furnace, which recovers a Zinc Oxide rich dust, CZO (Crude Zinc Oxide), but it produces a large quantity of waste, a hazardous material. Danieli proposes a better alternative technology: the Indutec<sup>®</sup> technology. This new patent process is much more attractive than the Waelz kiln, because, in addition to the production of CZO (Crude Zinc Oxide), it also allows the recovery of pig iron. In addition, the slag from the process is an inert metallurgical slag which can be recovered. When a sufficient quantity of CZO is available, for instance from the Indutec<sup>®</sup> process applied to the EAF Dust produced with a large meltshop, or with a number of smaller ones, then the further treatment of CZO is economically feasible and the Ezinex<sup>®</sup>, the technology of second level, is the outstanding hydro-metallurgical process for producing electrolytic Zinc from CZO. Danieli believes that the Indutec<sup>®</sup> process is an outstanding combination meeting all following goals: Proven process, Economically feasible process, Significant contribution to Zero-Waste electric steelmaking.

**Key words:** Zinc oxide; Dust; Fume treatment plant in steelmaker; Steelmaker dust; Electric arc furnace dust.

<sup>1</sup> *Technical contribution to the 44<sup>th</sup> Steelmaking Seminar, May, 26<sup>th</sup>-29<sup>th</sup>, 2013, Araxá, MG, Brazil.*

<sup>2</sup> *Engineer, Proposal Manager, Danieli Centro Met, Environment LPD, Buttrio, Italy.*

<sup>3</sup> *Engineer, Director, Danieli Centro Met, Environment LPD, Buttrio, Italy.*

## 1 INTRODUCTION

The quantity of fume abatement dust generated annually by a 1 Mtpy steel meltshop can be up to 25,000 tonnes, depending on the steel produced and raw materials used.

EAF dust is classified as a hazardous waste by most environmental control agencies, and its safe disposal cost ranges between €100 and €150 per tonne. In particular situations, the disposal cost can be even higher.

The economical cost of disposal is not the only factor driving the need for a dust recovery system, because often environmental permitting mandates for the use of BAT (Best Available Techniques) and waste reduction and recovery are always at the top of the hierarchy of the various waste disposal options.

Danieli is committed to build “zero-waste” meltshops, thus the recovery of EAFD (Electric Arc Furnace Dust) is a priority of the company’s environmental department, which has conducted a review of the recovery systems developed in the last three decades.

The most common process is the Waelz furnace, which recovers a zinc oxide rich dust, CZO - Crude Zinc Oxide, having a substantial commercial value, because its zinc content is in excess of 50%. A major drawback of the Waelz process, and of other similar systems, is that it produces a large quantity of waste, which should be classified as hazardous material due to the risk of leaching out the heavy metals contained by the Waelz slag.

The Indutec<sup>®</sup> process, developed by Danieli S.p.A. in collaboration with Engitec Technologies S.p.A. Italian companies, is much more attractive than the Waelz kiln, because, in addition to producing CZO (Crude Zinc Oxide), it allows also for the recovery of pig iron. In addition, the slag from the process is a metallurgical slag which can be recovered by using the Global Blue process of Danieli, successfully implemented at the ABS meltshop.

When a sufficient quantity of CZO is available, for instance from the Indutec<sup>®</sup> process applied to the EAF dust produced by a large meltshop, or from a number of smaller, the further treatment of CZO is economically feasible and the Ezinex<sup>®</sup> technology, also developed by Engitec, is the outstanding hydro-metallurgical process for producing pure electrolytic zinc from CZO.

Danieli has teamed with Engitec for the design and construction of EAFD recovery plants, because it believes that the INDUTECH<sup>®</sup> process followed by the Ezinex<sup>®</sup> is an outstanding combination meeting all following goals:

- proven process;
- economically feasible process;
- significant contribution to zero-waste electric steelmaking.

## 2 MATERIAL AND METHODS

### 2.1 History of Process

Both the Indutec<sup>®</sup> and Ezinex<sup>®</sup> processes have been successfully tested in Osoppo, Italy at the electric steelmaking plant belonging to the Pittini Group.

After extensive testing in the laboratory, in 1993 Engitec built a pilot plant designed to treat 500 tpy of EAFD, which provided positive results. Based on this experience, in 1996 an industrial plant using the Ezinex<sup>®</sup> hydrometallurgical process was built by Engitec in Osoppo for the production of electrolytic zinc.

The capacity of the Osoppo plant was 12,000 tpy of EAFD, corresponding to 2,000 tpy of zinc product.

Initially, the plant showed the following limitations:

- the variable composition of EAFD made difficult to control the process in order to maintain constant the quality of the zinc product;
- it was not possible to recover the zinc fraction bound by iron in the form of zinc ferrites and, at the same time, it was difficult to melt in the EAF the iron containing by-product;
- the operational costs of the Ezinex<sup>®</sup> system were excessive due to the small size of the Osoppo plant.



**Figure 1.** EZzinex<sup>®</sup> and Indutec<sup>®</sup> plant.

At this point, Engitec ideated the Indutec<sup>®</sup> process, which recovers CZO from EAFD and, at the same time, produces pig iron containing the iron fraction included in the zinc ferrites.

The combination of the Indutec<sup>®</sup> process with the Ezinex<sup>®</sup> process was the solution of the process issues.

Unfortunately the economic feasibility of the small Osoppo plant was not adequate and the plant was dismantled for making room for other steelmaking equipment.

At the same time, the development of an “EAF Dust District” including a number of Indutec<sup>®</sup> plants located at steel plants of Northern Italy and one centralized Ezinex<sup>®</sup> plant for the treatment of the CZO produced by the Indutec<sup>®</sup> plants was aborted due to the low market price of zinc, which at the end of the 2001 went below 750 US\$ per tonne, compared with today’s price of approximately 2,000 US\$ per ton.

## **2.2 The Indutec<sup>®</sup> Process**

Indutec<sup>®</sup> is a zinc enriching process for EAFD, based on the use of an induction furnace, which has been ideated and patented by Engitec.

The functions of this smelting process are as follows:

- full recovery of EAFD, a hazardous waste which requires expensive disposal methods;
- concentration of zinc, lead and other heavy metals in the CZO, a product which can be marketed as it is or, when available in sufficient quantities, processed for the production of electrolytic zinc;
- recovery of pig iron, which can be recycled back to the EAF, with subsequent saving of raw materials (steel scrap and DRI);
- production of non-hazardous, inert metallurgical slag, similar to the slag produced by the EAF, which can be easily processed for a full recovery.

The dust derived from the EAF fume abatement is stored in silo, from which it is extracted and sent to a pelletizing machine together with a dosed quantity of powdered coal. Water and binders are added to the pelletizing machine to produce EAFD pellets which are preheated in a rotating drum used for conveying (counter-flow) the hot fumes sucked from the induction furnace.

The core of the process is a low-frequency, core-less induction furnace, batch charged with preheated EAFD pellets, which falls into a pig iron bath heated and stirred by the induction process.

At the end of the smelting process, iron oxides are reduced and recovered as pig iron ingots, while the liquid slag is poured and cooled down.

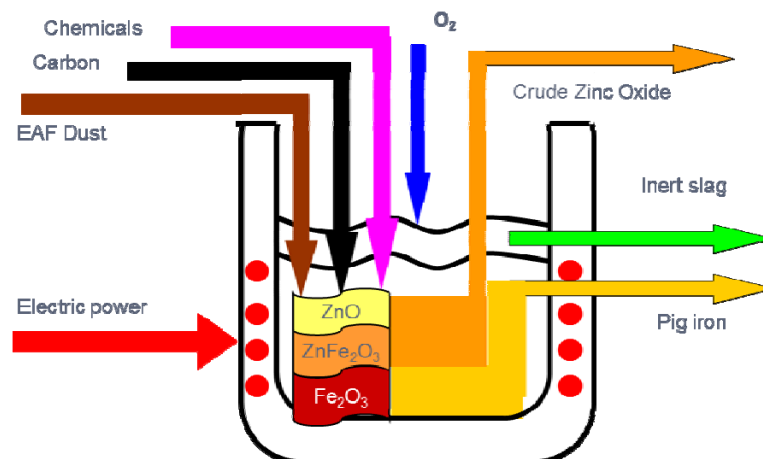

Figure 2. Pyrometallurgic Indutech® process.

At a temperature of approximately 1,450°C, zinc oxide is reduced and vaporized. Zinc and lead are fully volatilized and recovered by filtering the furnace flue gas with a bag filter. The material extracted from the filter is CZO - Crude Zinc Oxide.

The reactions governing the recovery of zinc (and other heavy metals) are the following:



The zinc vapours pass through the pellet layer and part of the zinc is condensed on the colder surface of the pellets:



The zinc leaving the pellet layer is oxidized by the oxygen present in the drying drum;



Also the following two reactions take place on the pellet surface;

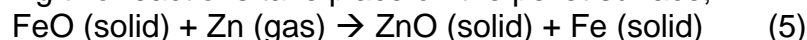

The reactions 1 to 4 show how zinc is extracted from the pellets and concentrated in the fumes.

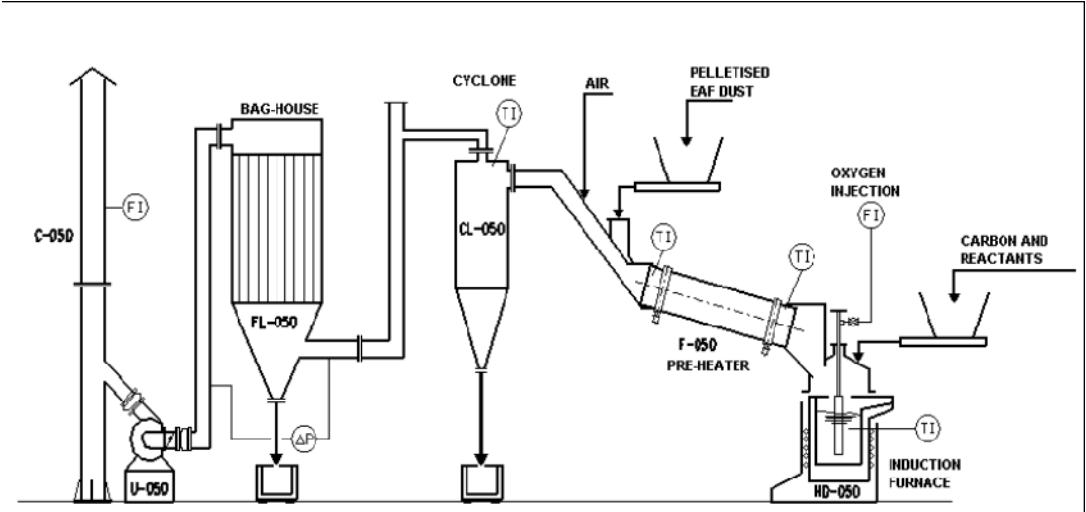

Figure 3. Indutec® plant.

To recover CZO, the fumes are cooled and filtered with a bag filter, which separates the product from the fumes.

**2.3 Mass Balance of the Indutec® Process**

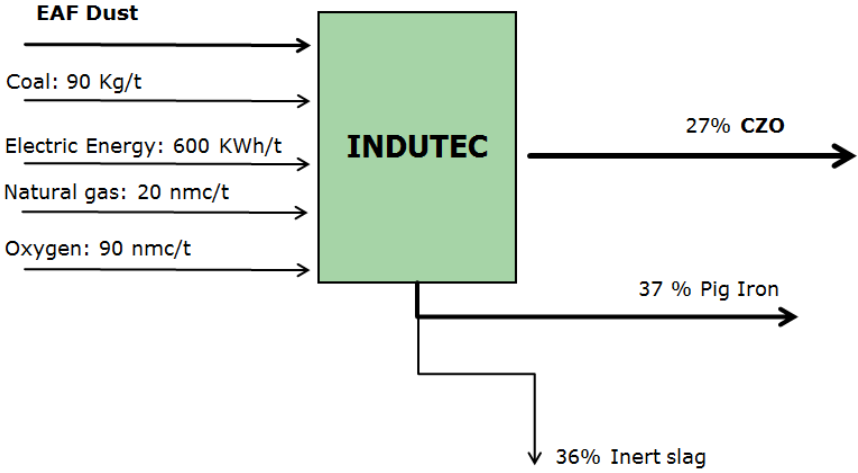

Figure 4. Mass Balance of the Indutec® Process.

The mass balance of the Indutec® Process depends on the quality of the processed EAFD, while the quality of the zinc product is not dependant from the input material. In any case, the recovery rate is 100% for all components of EAFD, because the process does not produce any residue, except for the materials which are recycled within the process itself.

Also the Indutec® process was tested at the Osoppo plant, in combination with the Ezinex® system. More recently, the concept of using an induction furnace for enriching EAFD has been applied to a 100,000 tpy EAFD recycling plant located in Arkansas. This plant operates under a license agreement relative to the Engitec patent of Indutec®.

## 2.4 The Ezinex<sup>®</sup> Process

Ezinex<sup>®</sup>, an acronym from “*Engitec Zinc Extraction*”, is the name of a patented hydrometallurgical system based on the following main leaching reaction:

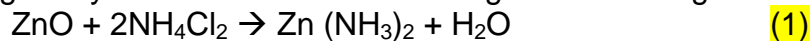

The leaching reaction (1) for a generic metal is as follows:

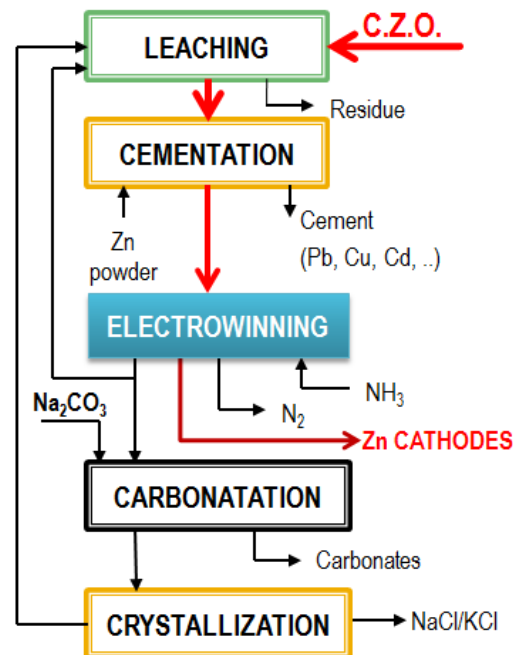
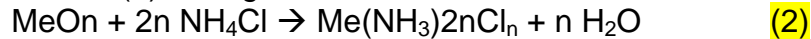

Figure 5. Ezinex<sup>®</sup> hydrometallurgical system.

The electrolyte is based on ammonium and alkali chlorides, with a zinc content of 10 g/l -15 g/l, and is used at a temperature of 70°C-80°C.

Other metals, such as Cu, Cd, Ni and Ag, react with a similar mechanism, while Pb goes into solution due to the strong action of the chloride ions.

Iron oxides, ferrites and silica are not dissolved. The obtained slurry is filtered with a filter press which separates a solid phase (insoluble fraction) from a rich electrolyte solution.

During the leaching, the alkali chlorides are solubilised, increasing the chloride content of the solution. This factor is very important, because there is no need to pre-wash the input material, as it is necessary with the traditional leaching systems. It is obvious that chlorides washing results in waste-water being generated, with consequent need of waste water treatment.

The material from the filter press can be recycled to the EAF, after drying below 10% moisture. Before going to the EAF, coal powder is added to optimize the reuse.

The metal rich electrolyte, contaminated by other heavy metals solubilised during the leaching phase, is purified with the addition of zinc powder, according to a reaction which takes place in the cementation reactor, where the zinc powder reduces to elemental conditions the metals which are more noble than zinc, such as Cu, Pb, Cd, Ni and Ag.

The generic cementation reaction, where the metal Me is Ag, Pb, Cu or Cd, is as follows:

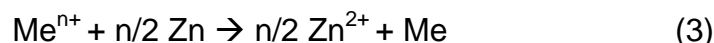

The core of the Ezinex<sup>®</sup> process is the electrolysis section, including electric conversion (from AC to DC) and electrolysis cells with titanium cathodes and graphite anodes.

The electrolyte is fed through one side of the cell and overflows at the opposite side. Water vapour extracted from the cells is mostly recycled to an air sparging system used in the cell while the rest is processed with a scrubber.

Metallic zinc is deposited on the cathode, while the anode releases nitrogen produced by the oxidation of free ammonia. This reaction is important, because it prevents the development of gaseous chlorine.

The electrowinning reactions are as follows:

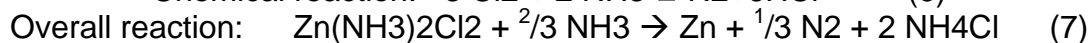
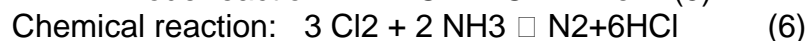
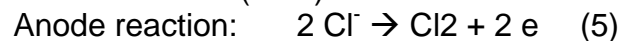
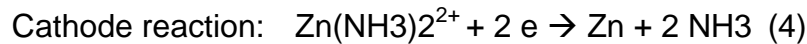

After separation of zinc, the solution is recirculated to the leaching reactor, where another process cycle starts.

Alkali metals tend to accumulate in the electrolyte, thus it is necessary to purge some liquid and process it through an evaporator, which separates salts by concentration and crystallization. The vapour produced is condensed and re-used in the plant for tanks heating, pump sealing and scrubber make-up.

## 2.5 Energy Requirements

The process requires electric energy, particularly for the functioning of the induction furnace (Indutec<sup>®</sup>) and the electrolytic phase (Ezinex<sup>®</sup>).

In addition, oxygen is used in the Indutec<sup>®</sup> and natural gas both in the Indutec<sup>®</sup> and in the Ezinex<sup>®</sup> process.

**Table 1.** Summarize of the energy requirements

Energy Consumptions			
Indutec <sup>®</sup>	Electric Energy	600	kWh/t EAF dust
	Oxygen	90	Nm <sup>3</sup> /t EAF dust
	Natural Gas	20	Nm <sup>3</sup> /t EAF dust
Ezinex <sup>®</sup>	Electric Energy	3,600	kWh/t Zn slabs
	Natural Gas	20	Nm <sup>3</sup> /t Zn slabs

## 2.6 Steelmaker and the Indutec<sup>®</sup> Process

Danieli proposes to the steel producers, the Indutec<sup>®</sup> Process, a zinc enriching process for EAFD, based on the use of a pyrometallurgic process by an induction furnace.

A process easy to manage. A process that recovers 100% of the dust from fume treatment plant in steelmaker.

A process that produces some products with a high value:

- crude zinc oxide with a high concentration of zinc, lead and other heavy metals, which can be marketed as it is or, when available in sufficient quantities, processed for the production of electrolytic zinc;

- pig iron, which can be recycled back to the EAF, with subsequent saving of raw materials (steel scrap and DRI);
- inert metallurgical slag, similar to the slag produced by the EAF, which can be easily processed for a full recovery.

### 3 RESULTS

#### 3.1 Product Specification

##### 3.1.1 Crude zinc oxide

Crude Zinc Oxide CZO has a substantial commercial value, because its zinc content is in excess of 50%. The value of this product is regulated from the London Metal Exchange (LME) and follows the Zinc value.



Figure 6. Zinc quotation in LME.

The value of the oxide of zinc is about a quarter of the value of the electrolytic zinc, depends on the quality obtained.

##### 3.1.2 Pig iron

Table 2. Process' composition of the pig iron produced by the Indutec®

Component	Percent by Weight
Iron	92÷94 %
Carbon	3÷4 %
Copper	< 2 %

The content of copper is not a problem when the product is used for steelmaking diluted with standard steel scrap.

##### 3.1.3 Inert slag

The advantage of the process is that the slag leaching does not generate toxic liquid and thus is not classified as a hazardous material.

The quality of the slag is similar to the metallurgical slag produced by an electric arc furnace, thus it can be used for the production of aggregate to be beneficially sold to the construction industry for road asphaltting or for the construction of concrete pavements.



Ecogavel® is the trade name of the main product of the Danieli slag recovery system, which through a combination of grinding and sieving produces various sizes of aggregate having mechanical properties better than those of natural aggregate (gravel). The system is able to magnetically separate ferrous materials from the EAF slag. The process is completely automated and its operation requires personnel only for feeding the processing line and removing the end products.

Since December 2007, when the plant was started-up at the ABS electric melt shop in Udine, more than 300,000 tonnes of EAF slag have been recovered and successfully marketed for road asphaltting and for the production of cement mix. In ABS, the amount of recovered scrap metal is approximately 3% of the processed material. The steel scrap is recycled back to the EAF.



**Figure 7.** Ecogavel® process to recover slag.

## **4 DISCUSSION**

### **4.1 Design**

Danieli analyses the specific problem of the customer and develops and projects a specific solution. Danieli is flexible in designing a process which takes into consideration the specific requirements of each project.

Below a specific process diagram and drawing, suitable for the production of dust of a Steelmaker that produce from 1 to 2 million tonnes of liquid steel.

This solution is based on 2 induction furnaces.

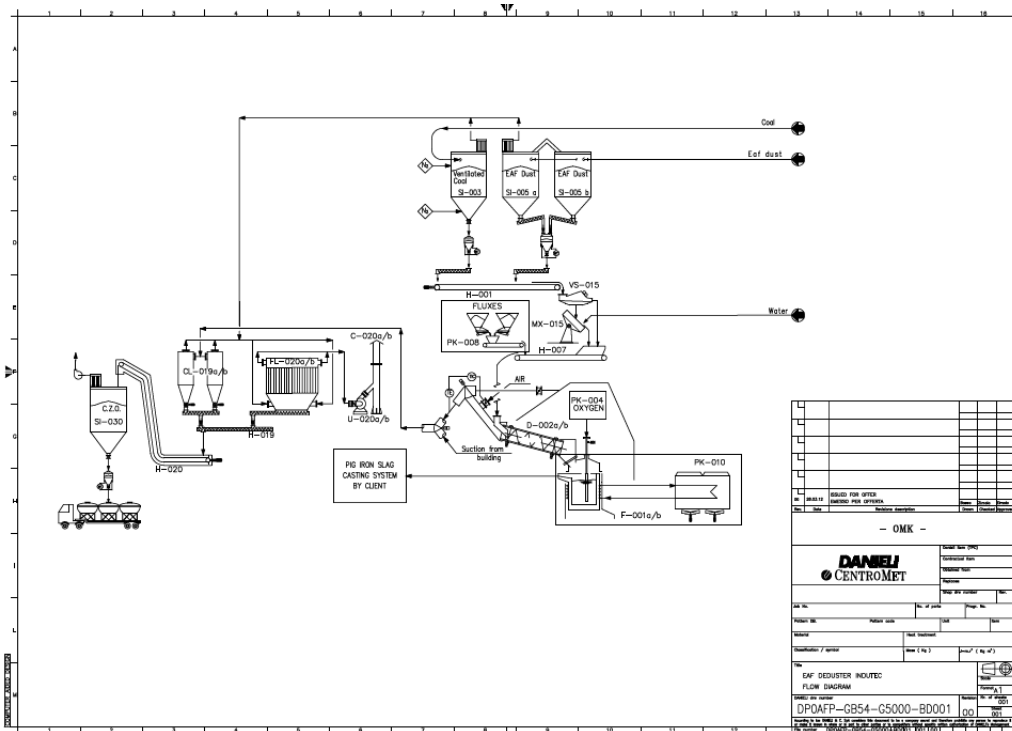

Figure 8. Flow-Sheet.

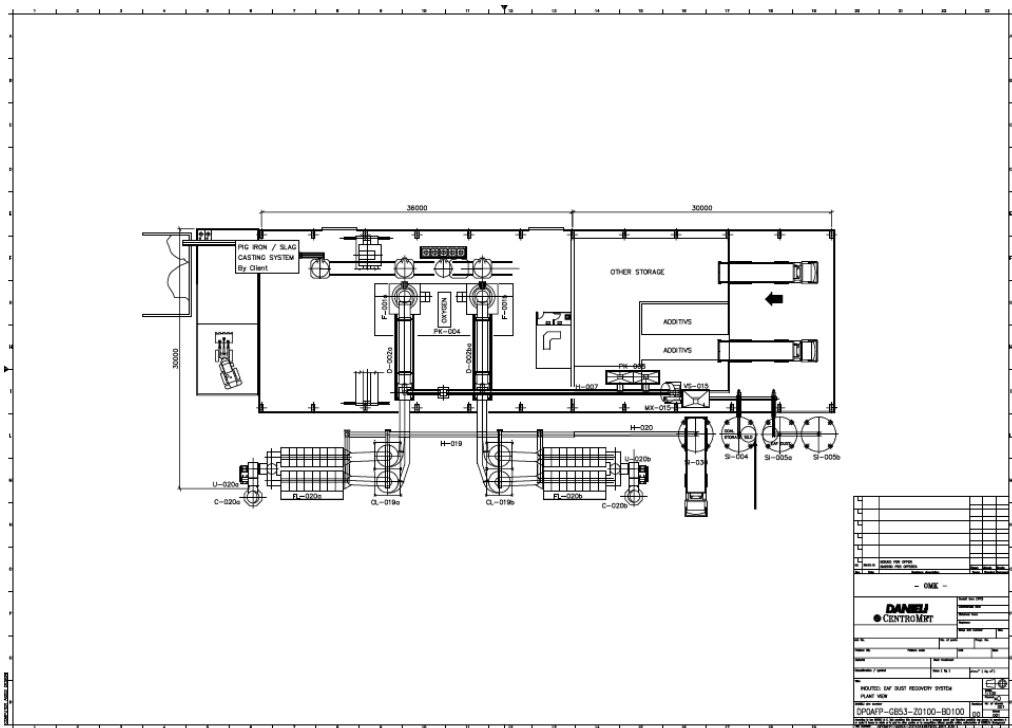

Figure 9. Drawing.

## 4.2 Case Study

Input	40.000 tpy EAF dust @ 15% of Zinc content
Operational conditions	250 wddpy, 6-7 t/h productivity
Output	10.000 tpy CZO @ 58% of ZnO content
	8.000 tpy Pig Iron
	16.000 tpy Inert slag

**Table 3.** European costs

<b>Operational cost</b>				
	<b>Unit</b>	<b>Unit/ton</b>	<b>\$/unit</b>	<b>\$/ton Eafd</b>
<b>Labor</b>	hour	1,5	20	29,99
<b>Electric energy</b>	KWh	600	0,1	60,00
<b>Natural gas</b>	Nm3	20	0,2	4,00
<b>Coal</b>	Kg	90	0,1	9,00
<b>Oxygen</b>	Nm3	90	0,12	10,80
<b>Fluxant</b>	kg	20	0,18	3,60
<b>Maintenance</b>				15,00

<b>Operational cost</b>				
<b>Slag disposal</b>	Ton	16000	30	480.000

<b>Operational cost</b>				
<b>Total yearly cost</b>				5.680.000

<b>Product sales revenues</b>				
	<b>Unit</b>	<b>Ton/year</b>	<b>\$/ton</b>	<b>\$/year</b>
<b>Crude Zinc Oxide</b>	Ton	10000	500	5.000.000
<b>Pig Iron</b>	Ton	8000	250	2.000.000
				7.000.000

<b>Savings</b>				
	<b>Unit</b>	<b>Ton/year</b>	<b>\$/ton</b>	<b>\$/year</b>
<b>Eaf dust</b>	Ton	40000	90	3.600.000

## 5 CONCLUSIONS

The Indutech<sup>®</sup> Process is the only proven process which can offer all the following advantages:

- full recovery of Electric Arc Furnace Dust. This is a “Zero-waste”;
- production of Crude Zinc Oxide of “Prime Western” quality, having a price quoted at the LME London Metal Exchange, the world's premier non-ferrous metals market;
- recovery of the iron fraction contained by EAFD, which is used as raw material in the EAF;
- production of inert slag, recyclable with a simple mechanical treatment for the production of Ecogravel<sup>®</sup>;
- environmentally sustainable, not only due to the full recovery of a hazardous waste, but also because the process does not require to wash out the chlorides from the CZO prior to the hydrometallurgical treatment (washing produces a large amount of waste water).

Our Vision is “Zero Waste” in Steelmaking.